

# Oil Burner Safety Control

**For 2-stage oil burners with post-purge and intermittent operation**

**Flame detection:**

- Photoresistor MZ 770 S
- Infrared-flicker detector IRD 1010.1
- UV flame sensor UVD 970

## INTRODUCTION

The DKO 992 oil burner safety control boxes are suitable for oil burners with with post-purge. They are approved and certified according to the applicable European standards and regulations.

The microprocessor-based programming sequence ensures extremely stable timings independent of voltage variations, ambient temperature and/or switch-on cycles. The built-in information system not only provides a continuous monitoring of the actual state of the box (very helpful especially for monitoring the start-up phase) but also informs about the possible cause of a lock out. The lock out cause is stored in such a way that it can be retrieved even after a power failure.

The control box is designed for maximum safety in case of variations in the voltage supply. If the mains voltage drops below the permitted level, operation is interrupted and the control box automatically prevents the start sequence from being repeated. In this way, the safety of the system is not put at risk by a drop in the mains voltage. This low-voltage protection works not only during start-up but also permanently during operation.

## TYPES AVAILABLE

DKO 992 2-stage operation

## CONSTRUCTIONAL FEATURES

The control box circuitry is protected by a flame resistant, transparent plug-in type plastic housing. A central fixing screw locks the control box to the wiring base.

The plug-in control box incorporates the microprocessor based timer, flame check and reset circuits.

Manual reset from lock out and set to lock out is provided by a push button with an integrated LED information system. The wiring base S98 is equipped with spare- and extra terminals and allows, together with a variety of cable entry points, utmost flexibility of electrical wiring.



## TECHNICAL DATA

Operating voltage	220 / 240 V (-15... +10%) 50 / 60 Hz (±5%)
or	110 / 120 V (-15... +10%) 50 / 60 Hz (±5%)
Fuse rating	10 A fast, 6 A slow
Power consumption	ca. 12 VA
Max. load per output	
- term. 3 ignition trafo	1.5 A, cos φ 0.2
- term. 4 motor	2.0 A, cos φ 0.4
- term. 5 + 6 solenoid valves	1,0 A, cos φ 0.4
- term. 7 alarm indicator	1,0 A, cos φ 0.4
total load	5.0 A, cos φ 0.4 max. 16 A during 0,5 sec
Reset time from lock out	none

## Re-cycling (repetition) after a loss-of-flame during operation

Flame detectors	< 2 m length of cable
MZ 770 S	side-on and end-on viewing
Light sensitivity	better 6 Lux
IRD 1010.1	side-on or end-on viewing
UVD 970	end-on viewing
Weight incl. Wiring base	190 g
Mounting position	any
Protection class	IP 40
Approved ambient parameter for control and flame detector	max. 95% bei 30° C
- for operation	-20° C... +60° C
- for storage	-20° C... +80° C
Build-up of ice, penetration of water and condensing water are	inadmissible
Approvals according to European standards	EN 230, as well as all other relevant Directives and standards

**Table of timings (sec.)**

Model	Pre-purge and pre-ignition time <b>tv1</b>	stray light monitoring <b>tf</b>	safety time <b>ts</b>	post-ignition time after V1 <b>tn</b>	delay time to V2 <b>tv2</b>	post-purge time <b>tnb</b>
<b>05</b>	15	5	5	7	20	20

## APPLICATION FEATURES

### 1. Information system

The information system is microprocessor based and reports on all aspects of burner control box operation and flame supervision. It informs continuously about the actual programming sequence the unit is performing. Besides monitoring the programming sequence, it also identifies errors during start-up of operation without any additional testing devices. The automatically performed diagnoses is a valuable tool which facilitates service/maintenance work and therefore saves costs. The analysis of the error cause can be done directly on stage or if not possible afterwards as the lock out reason is stored in a non-volatile lock out mode memory.

The information system communicates with the outside world using a LED (the used Flash-Code is similar to the Morse-Code). The messages are optically transmitted by flashing a LED appropriately. Using an (optional) additional terminal, the messages can be recorded and displayed in easy readable form.

#### 1.1 Programming sequence display

The built-in microprocessor controls not only the programming sequence but the information system as well. The individual phases of the programming sequence are displayed as Flash-Code.

The following messages can be distinguished:

Message	Flash-Code
waiting for RT	■ _
pre-ignition	.
tv1	
safety time ts	■   .
post ignition tn	
delay time to valve V2	■     .
tv2	
running	_
post-purge	■ ■ _
low mains voltage	■ ■ _
Internal fuse defect	■ _
> control box defect	

#### Description

- | = short pulse
- = long pulse
- . = short pause
- \_ = long pause

### 1.2 Lock-out diagnoses

In case of a failure the LED is permanently illuminated. Every 10 seconds the illumination is interrupted by a flash code, which indicates the cause of the error. Therefore the following sequence is performed which is repeated as long as the unit is not reset.

Sequence:

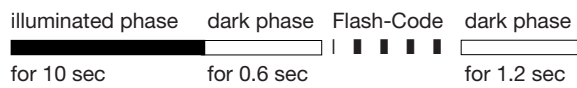

#### Error diagnosis

Error message	Flash-Code	Possible fault
lockout	■ ■ ■ ■	within lock out safety time no flame establishment
stray light	■ ■ ■	stray light during monitored phase, detector may be faulty
flame-off-test	■ ■ ■	flame signal during post-purge

#### Flash-Code for manual lock out

manual/external	■ ■ ■ ■ ■ ■ ■ ■
lock out	
(see also 3. lock out and reset)	

### 2. Flame control

The following detectors can be used for flame supervision:

- for yellow oil flame: photoresistor MZ 770 S (side-on and end-on viewing)
- for blue or yellow flame: infrared-flicker detector type IRD 1010.1 or as an alternative the UV solid state flame sensor UVD 970.

Generally, the no flame signal is generated at light levels below 3 Lux with respect to the operating cycle of the control. According to EN 230 stray light safety level has to be established in conjunction with the accompanying burner. Connecting the IRD 1010.1 or UVD 970 the correct wiring has to be observed.

#### 2.1 Stray light monitoring

The stray light check is performed at the end of the pre-purge time for the duration as mentioned in the table of timings.

#### 2.2 Post-purge/flame-off-test

The post-purge takes place if the control thermostat opens. During the post-purge the flame will be checked. If there is a flame signal the controller goes to the lockout position.

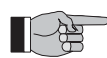

**If a lock out occurs during operation no post-purge will be carried out.**

### 3. Lock out and reset

The unit can be reset or brought into lock out mode in two different ways:

#### Internal

In the lock out case the unit can be reset by pushing the built-in button meaning a new start-up cycle is performed.

#### External

Instead of using the built-in lock out button the same function can be achieved by using an external button which connects terminal 9 with A (see also circuit and block diagram).

If the pushbutton (internal or external) is pressed during normal operation or during the start sequence for more than 3 sec. and afterwards released, the control box will perform a shutdown.

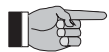

#### Please note

The unit can only be brought to lockout mode or be reset if power is applied to the unit.

### 4. Low-voltage protection

at 220 / 240V (110 / 120V) nominal voltage

The mains voltage has to be more than  $187 V_{\text{eff}}$  ( $94 V_{\text{eff}}$ ) in order to allow the unit to perform a start-up.

The mains voltage is not only monitored in the start-up phase but also permanently during operation. If the voltage drops below  $< 160 V_{\text{eff}}$  ( $80 V_{\text{eff}}$ ) during start-up or run time the control box proceed to safety shut-down and goes into a waiting status. If the voltage rises again, the control box automatically performs a start-up as soon as the mains voltage is  $> 187 V_{\text{eff}}$  ( $94 V_{\text{eff}}$ ).

### 5. Current frequency

The control boxes can be used with 50 Hz as well as with 60 Hz.



For the detection of the current frequency (50 Hz or 60 Hz) the control thermostat has to be closed.

### 6. Safety

The design and control sequence of the DKO 992 controls will comply with the currently applicable standards and regulations (see also TECHNICAL DATA).

### 7. Mounting and electrical wiring

Wiring base:

- 3 earth terminals with additional terminal for burner earthing
- 3 neutral terminals with internal permanent connection to neutral terminal 8
- 2 independent spare terminals (S1 and S2)
- extra terminals A, B and C are standard (wiring base S98 12-pin)
- 2 slide-in plates and 2 easy knock out holes plus 2 knock out holes in the base bottom facilitate the base wiring

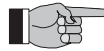

#### Please note

To assist trouble-free operation the main neutral connection terminal 8 in the wiring base must be fully tightened. The terminal screws are already in the undone position. To connect a wire to the terminal, the screw only needs to be fastened.

General: The control box and detector probes should not be subjected to excessive vibration.

## INSTALLATION INSTRUCTIONS AND MAINTENANCE

### 1. Important notes

- The controls must be installed by qualified personnel only. The relevant national regulations have to be observed.
- On commissioning, the wiring has to be carefully checked according the appropriate diagram, incorrect wiring can damage the unit and endanger the safety of the installation.
- The fuse rating has to ensure that the limits specified in TECHNICAL DATA will not be exceeded. If these precautions are not observed, the effect of a short circuit can cause severe damage to the control and installation.
- For safety reasons a minimum of one control shutdown every 24 hours has to be observed.
- Disconnect the power supply before the control box is plugged in or out.
- The control box is a safety device and must not be opened!

### 2. Function control

For safety reasons the flame detection system should be tested on commissioning the installation as well as after a service or longer shut-down.

- Start-up with covered flame detector
  - After lock out safety time is over the unit has to go into lock out mode!
- Start-up with exposed flame detector
  - After 10 sec prepurge time the unit has to go into lock out mode!
- Normal start-up with burner in the normal position, cover up the flame detector
  - After start-up, and end of lock out safety time the unit has to go into lock out mode!

### 3. Fault finding

The built-in information system facilitates the trouble shooting in the case of problems occurring during start-up or during operation.

A list of possible lock out messages can be found in APPLICATION FEATURES chapter 1.2.

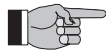

#### Please note:

**The control box is locked in lock out mode and the reason for the lock out is displayed until the control box is reset, either by an internal or external reset (see also subject "3. Lock out and reset").**

Removing the control box from its wiring base or by interrupting the supply line may **not** reset a lock out (according to EN 230). Therefore, by applying power, the fan motor switches on for 2-3 secs. before the control box goes to lock out again and the cause of the last lock out.

<b>Error</b>	<b>Possible fault</b>
Burner not working	- Thermostat circuit open - Faulty electrical wiring - Mains voltage < 187 V (< 80V) - Internal fuse defect - Terminal A continuously on power (e.g. terminal A is used as a support terminal)
Fan motor starts for a short period of time, control box goes to lock out	- Control box has not been reset
Burner starts, flame not established, lock out	- Stray light on flame detector - No ignition or no fuel
Burner starts, flame established, after safety time, lock out	- Dirty or faulty flame detector - Insufficient light on detector - Sensitivity adjustment too low on IRD
Lock-out after post-purge	- flame signal during post-purge (leaking valve or defective flame detector)

### CIRCUIT AND TIMING DIAGRAM DKO 992

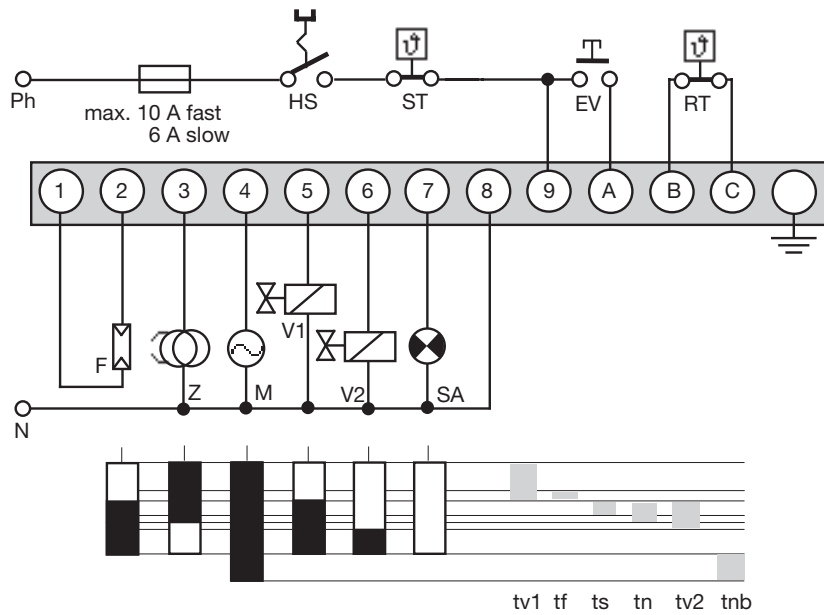

- HS Mains switch
- ST Limit thermostat
- RT Control thermostat
- EV External reset and lock out button
- F Flame detector MZ 770 S (IRD 1010.1, UVD 970 see separate diagram)
- Z Ignition
- M Burner motor
- V1 Oil solenoid valve, 1st-stage
- V2 Oil solenoid valve, 2st-stage
- SA External lock out signal
  
- tv1 Pre-purge and pre-ignition time
- tf stray light monitoring
- ts Lock out safety time
- tn Post-ignition time
- tv2 Delay time to oil V2
- tnb Post-purge

### IRD-/UVD-CONNECTION



### BLOCK DIAGRAM DKO 992

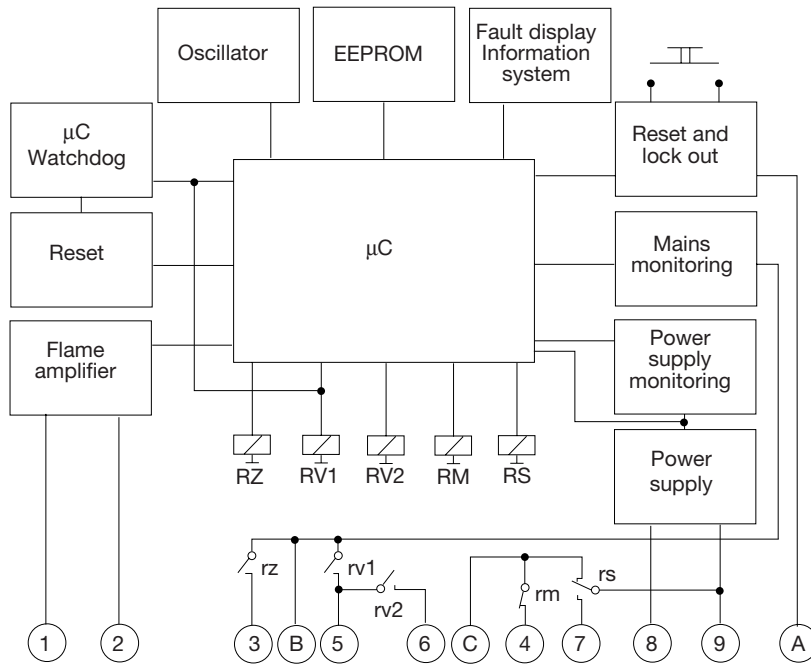

### DKO 992 AND SOCKET

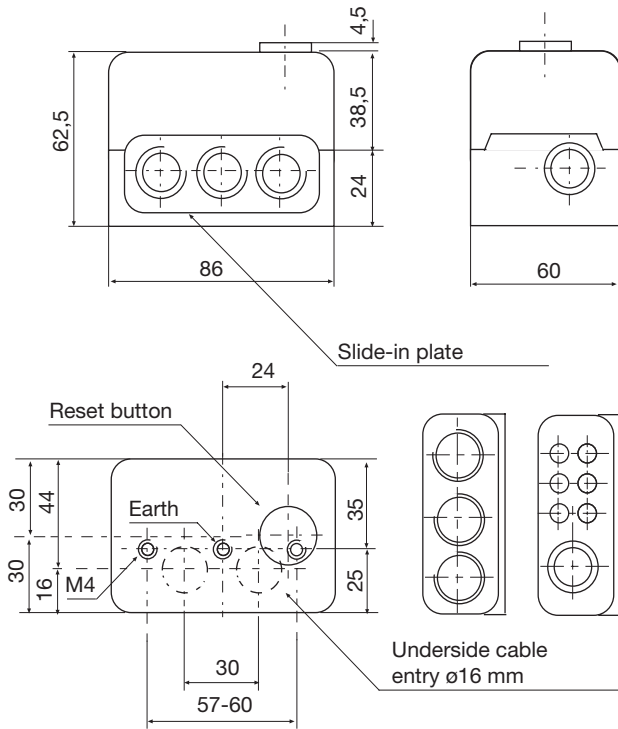

### HOLDER FOR MZ 770 S

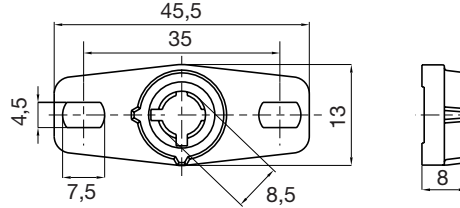

### SHAFT MZ 770 S

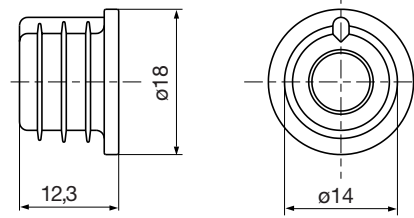

### PHOTORESISTOR MZ 770 S

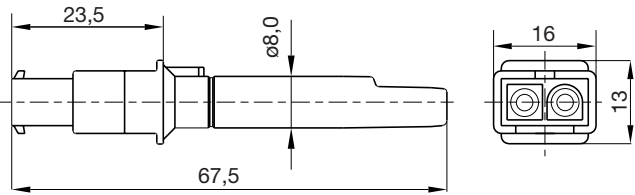

### UVD 970

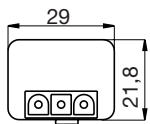

### IRD 1010.1

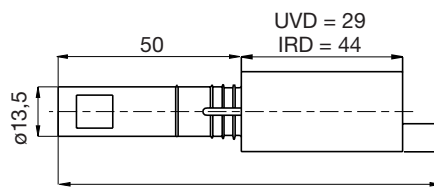
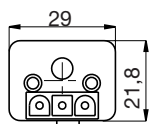

### HOLDER M74 FOR IRD OR UVD

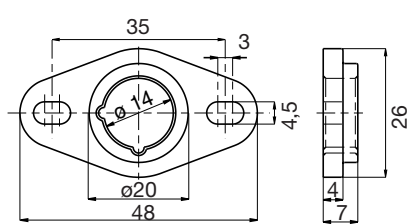

### VARIATION IRD

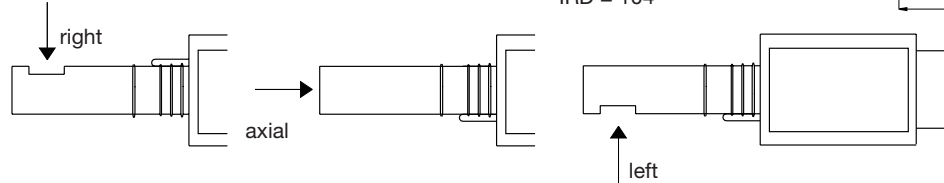

### ORDERING INFORMATION

ITEM	DESIGNATION	ITEM NO.
Control box	DKO 992 Mod. 05	0318005
Control box	DKO 992 Mod. 05 110 / 120V	0318305
Socket	Wiring base S98 12-pin	75310
Insert plate	PG-Plate	70502
optional	Cable entry plate	70503
Flame detector	MZ 770 S	50001
optional	MZ 770 S with shaft	51001
optional	IRD 1010.1 right	16501
	IRD 1010.1 end-on	16502
	IRD 1010.1 left	16503
	UVD 970	16702
optional	Holder for MZ 770 S	59101
optional	Holder M 74 for IRD or UVD	59074
Connection cable	Plug type, 3 core cable, 0.6 m with tag wire ends	7236001
Connection cable	Plug type, 2 core cable, 0.5 m with tag wire ends	7225001

The above ordering information refers to the standard version.  
Special versions are also included in our product range.

Specifications subject to change without notice

# DKO 992



Satronic AG  
Honeywell-Platz 1  
Postfach 324  
CH-8157 Dielsdorf