

# IGNITION TRANSFORMERS

TRASFORMATORI  
D'ACCENSIONE





# INDEX

## INDICE

<b>Company</b> Azienda		page	4
<b>Technology</b> Tecnologia		page	6
<b>Electronic Transformers</b> Transformatori elettronici	<b>Characteristics, outlets, inlets</b> Caratteristiche, ingressi, uscite	page	8
<b>Inductive Transformers</b> Transformatori induttivi	<b>Characteristics, outlets, inlets</b> Caratteristiche, ingressi, uscite	page	9
<b>Electronic Transformers</b> Transformatori elettronici	<b>The applications</b> Le applicazioni	page	10
<b>Inductive Transformers</b> Transformatori induttivi	<b>The applications</b> Le applicazioni	page	12
<b>TRK<sub>VD</sub></b>		page	14
<b>TRK<sub>HK</sub></b>		page	16
<b>TRK<sub>HD</sub></b>		page	18
<b>TRJ</b>		page	19
<b>TRJ<sub>3</sub></b>		page	20
<b>TRM</b>		page	21
<b>TRL</b>		page	22
<b>TRH</b>		page	23
<b>TRW<sub>1</sub></b>		page	24
<b>TRW<sub>2</sub></b>		page	25
<b>TRE</b>		page	26
<b>TRS</b>		page	28
<b>TRG</b>		page	30
<b>TRZ</b>		page	32
<b>Accessories</b> Accessori		page	33

# COMPANY

AZIENDA



4

## COFI, since 1974

The company was founded in 1974 with the aim of applying an innovative technology in the production of transformers for the ignition of gas burners and diesel. The application of this technology has revolutionized traditional production techniques for the isolation of high voltages, improving the electrical properties and durability, increasing the mechanical properties and while reducing the environmental impact of the materials used in the isolation.

The company has grown steadily investing in the search for solutions, materials and equipment.

## Technology

The technology applied to the construction of high-voltage insulation of the highest quality, is the driving force behind the company and represents a breakthrough in this area.

The high insulation is obtained by a combined system of encapsulating low pressure of thermosetting epoxy resin and the use of technology to polyester film in the insulation of the coils.

The benefits of this innovative combination are manifold:

- Mechanical properties and excellent aesthetic
- Electrical properties of unquestionable superiority
- Resistance to high temperatures superior to other materials traditionally applied
- Heat dissipation extremely effective
- Excellent resistance to chemicals and fuels
- Elimination of harmful materials from the manufacturing

process resulting in volatile reducing environmental impact.

This production process has shown its validity technology both conceptually and in practice, with millions of applications, used for many years by leading manufacturers internationally recognized.

The policy of the company throughout its history has always been directed towards the achievement of total quality is constructive and aesthetic, paying particular attention to the supply of top quality materials and following the technological changes constantly.

## R&D

COFI has always invested heavily in research and development, while continuing to improve existing products and to find new solutions to the increasingly demanding market. In recent years COFI products range has been able to benefit from this ongoing research with the release of several new and innovative products in the field of ignitions, making only the width of the range in this area. COFI is also able to provide a customized product for any need, our technical department is available to test the feasibility and to perform sampling of non-standard specifications. COFI constructs in series ionizers transformers, demagnetizers, voltage doublers, equipment for fencing and other areas that do not belong to the world of ignitions where the construction of the transformer is sometimes considerably distant from the standard. ionizers also works on the development of sensors and transducers that produce using our technology.

COFI is also active in the field of fuel cells with important research projects in the field of renewable energy in collaboration with important Italian and foreign universities, earning critical patents in this field.

## Service

The optimal application of the high-voltage requires a careful study of the accessories to guarantee a certainty of ignition performance, therefore the maximum attention is dedicated to the study of functions of the cables and connections of the protections of the outputs of high tension, with the realization of parts that integrate various solutions in a single cable, eliminating assembly difficulties and uncertainties of operation.

The company also takes great care of the special needs of the customer, realizing also accessories specification, studying the effectiveness and optimization. Relevant in this regard is the EMC measures laboratory with the latest generation of equipments for performing measurements of electromagnetic compatibility according to EN55014 standards, and the subsequent study of the details necessary to make compatible the installation of the transformer.

Most of the products are certified by the most representative organizations in Europe such as VDE, IMQ and SEV, as well as UL and CSA for the American market.







## COFI, dal 1974

L'azienda è stata fondata nel 1974 con l'obiettivo di applicare una tecnologia innovativa nella produzione dei trasformatori per l'accensione di bruciatori a gas ed a gasolio. L'applicazione di questa tecnologia ha rivoluzionato le tradizionali tecniche produttive per l'isolamento delle alte tensioni, migliorandone le proprietà elettriche e la durata nel tempo, incrementando le proprietà meccaniche e riducendo nel contempo l'impatto ambientale dei materiali impiegati nell'isolamento.

L'azienda è cresciuta costantemente investendo nella ricerca di soluzioni d'avanguardia, nei materiali e nelle attrezzature.

## Tecnologia

La tecnologia applicata alla costruzione di prodotti di alta tensione con isolamento di prima qualità, è il motore trainante dell'azienda e rappresenta una svolta in questo settore.

L'altissimo isolamento è ottenuto mediante un sistema combinato di incapsulaggio a bassa pressione di resina epossidica termoidurente e l'uso della tecnologia a film poliestere nell'isolamento delle bobine.

I benefici apportati da questa combinazione innovativa sono molteplici:

- proprietà meccaniche ed estetiche eccellenti
- proprietà elettriche di indiscutibile superiorità
- resistenza alle alte temperature superiori agli altri materiali tradizionalmente applicati
- dissipazione del calore estremamente efficace
- ottima resistenza ad agenti chimici ed oli combustibili
- eliminazione dal processo produttivo dei materiali dannosi volatili con conseguente riduzione dell'impatto ambientale.

Questo processo produttivo ha mostrato la sua validità tecnologica sia sul piano concettuale che

sul piano pratico, con milioni di pezzi prodotti, utilizzati da molti anni dai più importanti produttori internazionalmente riconosciuti. La politica dell'azienda nel corso

della sua storia è sempre stata indirizzata verso il raggiungimento di una qualità totale sia costruttiva che estetica, curando in particolare l'approvvigionamento di materiali di prima qualità e seguendone costantemente le evoluzioni tecnologiche.

## Ricerca

Da sempre COFI investe notevoli risorse in ricerca e sviluppo, continuando a migliorare i prodotti esistenti ed a trovare nuove soluzioni per il mercato sempre più esigente. Negli ultimi anni la gamma di prodotti COFI ha potuto beneficiare di questa continua attività di ricerca con l'uscita di numerosi nuovi ed innovativi prodotti nel campo delle accensioni, rendendo unica l'ampiezza di gamma in questo settore. COFI inoltre è in grado di fornire un prodotto personalizzato per qualsiasi necessità, l'ufficio tecnico è a disposizione per verificare la fattibilità e per eseguire campionate di specifiche non standard. COFI costruisce in serie trasformatori per ionizzatori, smagnetizzatori, duplicatori di tensione, apparecchiature per la recinzione e altri settori non appartenenti al mondo delle accensioni dove la costruzione del trasformatore è a volte sensibilmente lontana dallo standard. COFI collabora inoltre allo sviluppo di sensori e trasduttori che produciamo utilizzando la nostra tecnologia.

COFI è anche attiva nel campo delle fuel cell con importanti progetti di ricerca nel campo delle energie rinnovabili in collaborazione con importanti università italiane e straniere, ottenendo anche importanti brevetti in questo campo.

## Servizio

L'applicazione ottimale dei prodotti di alta tensione richiede un attento studio degli accessori a garanzia di una certezza delle prestazioni di accensione, pertanto viene dedicata la massima attenzione allo studio delle funzionalità dei cavi delle connessioni e delle protezioni delle uscite di alta tensione, con

la realizzazione di particolari che integrano varie soluzioni in un unico cavo, eliminando difficoltà di

montaggio ed incertezze di funzionamento.

L'azienda cura molto anche le esigenze particolari del cliente, realizzando anche accessori su specifica, studiandone l'efficacia e l'ottimizzazione.

Rilevante a questo riguardo, è il laboratorio di misure EMC dotato di apparecchiature dell'ultima generazione per l'effettuazione delle misure di compatibilità elettromagnetica secondo le Norme EN55014, e il conseguente studio dei particolari necessari a rendere compatibile l'installazione del trasformatore.

La maggior parte dei prodotti sono certificati dagli enti europei più rappresentativi come VDE, IMQ e SEV così come UL e CSA per il mercato nord americano.



# A COMPANY DRIVEN BY TECHNOLOGY

TECNOLOGIA:  
IL MOTORE  
TRAINANTE



6

## Construction of high-voltage transformers

The COFI transformers are manufactured with top-quality choice materials in accordance with CEI EN 61558-2-3. The copper wire used for the secondary circuit winding is H 180°C Class, while the wire for the primary circuit winding is H 200°C Class. The insulation between layers in the high-voltage coils is ensured by a polyester film with high dielectric constant. The transformer is then encapsulated with Araldite, a thermosetting epoxy resin resistant to a temperature of over 180°C, that offers it high mechanical resistance together with excellent dielectric properties, resistance to fuel oils and to chemical agents, very good thermal dissipation and - last but not least - elimination of harmful volatile materials from the production cycle. Moreover, the materials enable a surface finish that is comparable with metal. All the other components have been chosen from the best available on the market, taking into account the best resistance to temperature in order to ensure indestructibility even in the most severe duty conditions.

\* Available certification |  
Certificazioni disponibili

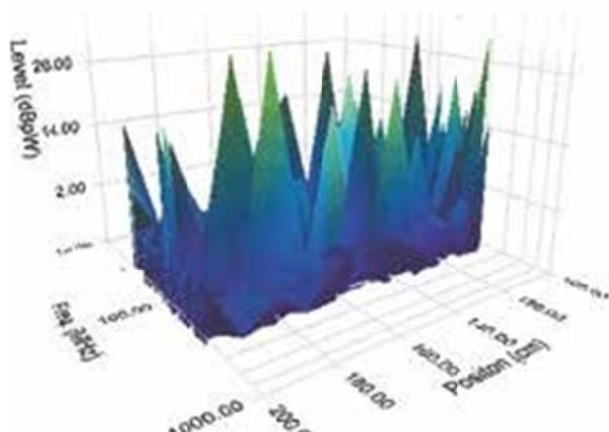

## Encapsulation

The company has developed over the years different systems of encapsulation with epoxy resins, to obtain the maximum level of insulation of different applications, always taking advantage of the best available technology on the market. In inductive transformers are used thermosetting epoxy resins to transfer injection, now widely used in the automotive industry. Electronic transformers are potted with epoxy resin under a very high vacuum. The line, fully automated, guarantees a constant quality on a large scale. Both systems offer exceptional performance and longevity of the product. The company is as always at the forefront in the isolation of high voltages and in production technologies.

## Operation cycles

The transformer can operate, depending on the type, on continuous or intermittent duty in accordance with the technology applied to the burner and the control device.

The transformers at intermittent duty can work at different inserting time, depending on the type: ED= 25% on 4' means that the transformer can be switched ON for 1 min. and then shall be OFF for at list 3 min. Total cycle time is 4 min. So ED= 33% on 3' means that the transformer work 1 min. ON and 2 min. OFF.

ED= 100% means that the transformers can operate continuously.

The electronic transformers are designed to work with ambient temperatures up to 60°C, the inductive one at 35°C.

## Electromagnetic Compatibility (EMC)

CE Marking made it mandatory for all manufacturers of consumer and industrial machines to comply with the European directives on low voltage 2006/95/CE and on electromagnetic compatibility 2004/108/CE. The discharge from the burner causes electromagnetic disturbance, both

conducted and radiated. The disturbance propagate differently

according to the set-up of the machine's electric connections or for instance the different opening of the terminals or the different positioning of the transformer in the machine. COFI laboratory found a general solution to help the users of transformers to not exceed the curves provided in the CEI ED 55014-1 standards.

## Final testing

All COFI transformers undergo strict final testing before being packed in order to ensure trouble-free operation and almost unlimited durability for the transformers that pass the test.

## Customized supply

In some applications, the input values (foreign countries) and the output values of the standard transformer as shown in our catalogue must be changed.

The personnel in our technical department checks if this can be done, and produces samples with non-standard features. We mass-produce transformers for ionizers, demagnetizers, voltage doublers, devices for fencing, and other fields apart from ignition devices, where the transformer often requires special features. We also develop sensors and transducers, which we manufacture, with our technology.

\* The indicated certifications are available on some models depending on the target market and the type of product, and are indicated in the product tables for each series. On request, it can be extended to models not currently approved. All products are still designed and built according to the standards IEC.

Le certificazioni indicate sono disponibili su alcuni modelli a seconda del mercato di destinazione e del tipo di prodotto, e sono indicate nelle tabelle prodotto di ciascuna serie. Su richiesta possono essere estese anche su modelli non attualmente omologati. Tutti i prodotti sono comunque progettati e costruiti secondo le normative standard IEC.





## Costruzione dei trasformatori di alta tensione

I trasformatori COFI sono costruiti rispettando la normativa di prodotto CEI EN 61558-2-3 utilizzando materiali di prima scelta e di massima qualità. Il filo di rame utilizzato è per l'avvolgimento secondario in classe H 180 °C, mentre per il primario è in classe H 200°C.

L'isolamento interstrato delle bobine di alta tensione è garantito da un film in poliestere ad elevata costante dielettrica.

Il trasformatore viene poi incapsulato con resina epossidica termoindurente Araldite resistente a temperature di fino a 180°C, che gli conferisce una elevata resistenza meccanica unita a ottime proprietà dielettriche, resistenza agli oli combustibili e agli agenti chimici, ottima dissipazione termica e, non meno importante, l'eliminazione dal ciclo produttivo di materiali dannosi volatili. Con questo materiale si garantisce un livello di finitura superficiale paragonabile al metallo.

Tutti gli altri componenti sono stati scelti tra i migliori sul mercato ricercando la massima resistenza alle temperature, in modo da garantire l'indistruttibilità anche in condizioni di utilizzo estreme.

## Incapsulaggio

L'azienda ha sviluppato negli anni diversi sistemi di incapsulaggio con resine epossidiche, per ottenere il massimo livello di isolamento su differenti appli-

cazioni, sfruttando sempre la miglior tecnologia disponibile sul mercato. Nei trasformatori induttivi si utilizzano resine epossidiche termoindurenti ad iniezione a transfer, oggi ampiamente utilizzate nel settore automobilistico. Nei trasformatori elettronici viene utilizzato un sistema epossidico ad altissimo vuoto, completamente automatizzato che garantisce una qualità costante su larga scala.

Entrambi i sistemi garantiscono prestazioni e longevità del prodotto eccezionali. L'azienda è come sempre all'avanguardia nell'isolamento delle alte tensioni e nelle tecnologie di produzione.

## Cicli di funzionamento

Il funzionamento del trasformatore può essere continuo o intermittente a seconda del modello e della tecnologia applicata al bruciatore ed al dispositivo di controllo utilizzato.

I trasformatori a servizio intermittente, possono lavorare con diversi tempi di inserzione, a seconda del modello: ED=25% su 4' significa che il trasformatore può restare acceso per 1 minuto, quindi deve restare spento per almeno 3 minuti. Il ciclo totale, in questo caso, sarà di 4 minuti. Così un ED=33% su 3' significa che il trasformatore può restare acceso per 1 minuto e spento per almeno 2 minuti. ED=100% significa che il trasformatore può lavorare a servizio continuo.

I trasformatori elettronici sono costruiti per lavorare con temperature ambiente fino a 60°C, gli induttivi 35° C.

## Compatibilità elettromagnetica

Con la marcatura CE si è reso obbligatorio per i costruttori di macchine civili e industriali il rispetto delle direttive europee sulla bassa tensione 2006/95/CE e sulla compatibilità elettromagnetica 2004/108/CE.

La scarica elettrica soffiata dal bruciatore è causa di disturbi elettromagnetici condotti e irradiati.

I disturbi si propagano in modo diverso a seconda di come sono cablati i vari collegamenti della macchina o a causa ad esempio della diversa apertura degli elettrodi, o del diverso posizionamento del trasformatore nella macchina.

Il laboratorio COFI ha trovato una soluzione generale per aiutare gli utilizzatori dei trasformatori a rimanere al di sotto delle curve dettate dalla norma CEI EN 55014-1.

## Collaudo

Tutti i trasformatori COFI, prima di essere imballati, subiscono un severo collaudo volto ad eliminare qualsiasi incertezza di funzionamento, assicurando così una durata pressoché illimitata del trasformatore che ha superato il collaudo.

## Forniture particolari

Per alcune applicazioni i valori sia d'ingresso (paesi stranieri) che d'uscita del trasformatore devono essere cambiati dai tipi di serie a listino. Il nostro ufficio tecnico è a disposizione per verificare la

fattibilità e per eseguire campionate di specifiche non standard. Costruiamo in serie trasformatori per ionizzatori, smagnetizzatori, duplicatori di tensione, apparecchiature per la recinzione e altri settori non appartenenti al mondo delle accensioni dove la costruzione del trasformatore è a volte sensibilmente lontana dallo standard. Collaboriamo allo sviluppo di sensori e trasduttori che produciamo utilizzando la nostra tecnologia.

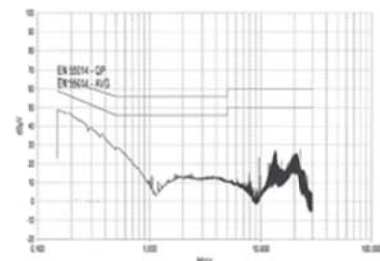
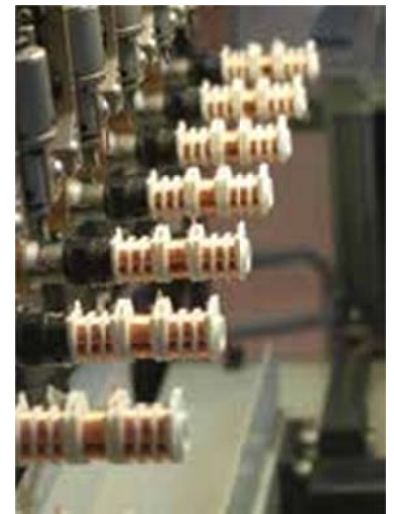

# ELECTRONIC IGNITION TRANSFORMERS

TRANSFORMATORI ELETTRONICI



8

Series of transformers designed with the electronic technology able to produce a discharge of high potential in high frequency (10-20kHz). There are several electronic configurations, from simple and more economical one, to the most sophisticated versions of high power and continuous operation with temperature and current control, for gas applications (1 pole) and oil application (2 poles). The power supply voltages ranging is from 100 Vac to 400 Vac, 12 and 24 Vdc. Thanks to the complete potting of transformer with premium resins, our electronic products enable safe operation even in extreme environmental conditions, from -20 ° C to + 60 ° C and on some models it is allowed to use it at also - 40 ° C or + 90 ° C. Numerous configurations, with inputs / outputs and dimensions, are available to meet international standards, making available a range of products suitable for any installation. The company also manufactures products tailored to the specific customer applications. All products are filtered internally against electromagnetic disturbances. The range of products suitable for use in the US market is approved (UL Recognized Component), while models for the European market are IMQ approved according to the product standard for burners EN 61558-2-3.

Serie di trasformatori progettati con la tecnologia elettronica in grado di produrre una scarica di alto potenziale in alta frequenza (10-20kHz). Sono disponibili diverse configurazioni elettroniche, dalle più semplici ed economiche, alle versioni più sofisticate di alta potenza e servizio continuo con controllo di temperatura e corrente, per applicazioni gas (1 polo) e gasolio (2 poli). Le tensioni di alimentazione vanno da 100 Vac a 400 Vac, 12 e 24 Vdc. Grazie all'impregnazione completa di tutto il trasformatore con resine di prima qualità, i nostri prodotti elettronici consentono una sicura operatività anche in condizioni climatiche estreme, dai -20°C ai +60°C e su alcuni modelli è consentito l'utilizzo anche a -40°C o +90°C. Sono disponibili numerose configurazioni con ingressi/uscite e ingombri per soddisfare gli standards internazionali, rendendo disponibile una gamma di prodotti adatti a qualsiasi installazione. L'azienda costruisce anche prodotti su misura adatti alle specifiche applicazioni del cliente con personalizzazioni anche molto spinte. Tutti i prodotti sono filtrati internamente contro i disturbi elettromagnetici. La gamma di prodotti adatti all'impiego nel mercato statunitense è omologata UL (recognized component), mentre i modelli per il mercato Europeo sono omologati IMQ secondo la normativa di prodotto per bruciatori EN61558-2-3.

<b>Serie TRK</b>	<b>Standard</b>
<b>Serie TRJ</b>	<b>Best Price</b>   Basso costo
<b>Serie TRH</b>	<b>High power</b>   Alta Potenza
<b>Serie TRL 12 e 24 Vdc</b>	<b>High power</b>   Alta Potenza
<b>Serie TRM 24 Vdc</b>	<b>Middle power</b>   Media potenza
<b>Serie TRW</b>	<b>Condensing Boilers</b>   Caldaie a condensazione
<b>Serie TRJ3</b>	<b>Smart igniter</b>   Trasformatore controllato <b>The power of an intermittent transformer with the guarantee of a continuous one</b> La potenza di un trasformatore intermittente con la garanzia di un continuo

## Applications | Applicazioni

The electronic ignition transformer is suitable to be applied to all kind of oil and gas burners, wall hang boilers, hot water high pressure cleaners and anti-mosquito equipment. These applications are indicated by a symbol beside each type of product as follows.

Il trasformatore elettronico può essere applicato a tutti i tipi di bruciatore a gas e gasolio, caldaie murali e idropulitrici. Queste icone rappresentano le applicazioni per ogni singolo prodotto.



## Inlets | Ingressi

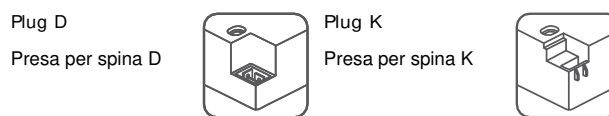

## Outlets | Uscite

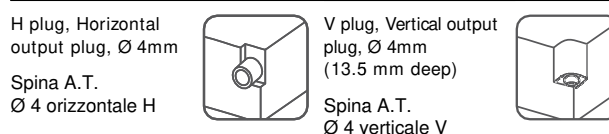



# INDUCTIVE TRANSFORMERS

TRANSFORMATORI  
INDUTTIVI



## Applications | Applicazioni

The conventional ignition transformer is suitable to be applied to all kind of oil and gas burners, hot water high pressure cleaners and anti-mosquito equipment. These application are indicated by a symbol beside each type of product as follows.

Trasformatore d'accensione convenzionale personalizzabile in numerose versioni per ogni tipo di applicazione, dai bruciatori alle idropulitrici, dalle zanzariere ai generatori di ozono. Disponibile in tensioni e frequenze di alimentazione per tutti i paesi del mondo. Il funzionamento a 50/60Hz ne garantisce la funzionalità anche con cavi di alta tensione molto lunghi.

Oil Burners

Bruciatori a gasolio



Gas Burners

Bruciatori a gas



Hot water high pressure cleaners

Idropulitrici



Anti-mosquito equipment

Zanzariere



## Inlets | Ingressi

These icons represent all the different kind of primary connection for each product

Queste icone rappresentano i tipi di prese di ingresso disponibili per ogni singolo prodotto

Standard buried cable L=380mm

Cavo annegato standard L=380mm

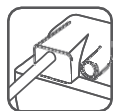

COFI plug

Presa per spina Cofi

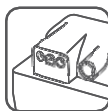

Triangle plug

Presa per spina Triangolo

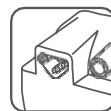

## Outlets | Uscite

These icons represent all the different kind of connection for each product

Queste icone rappresentano i tipi di uscite in alta tensione disponibili per ogni singolo prodotto

Code SP, plug, Ø 4 (21.5 mm deep) eccentric hole

Cod SP, Spina Ø 4 (prof. 21.5mm)

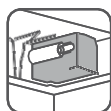

Code SPRO, hole Ø 6, plug Ø 4 for cable Ø 5.2 (35 mm deep)

Cod SPRO, Foro Ø 6, Spina Ø 4 (prof. 35mm) per cavo Ø 5.2

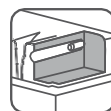

Code VIMAN, self-tapping screw with sleeve (25 mm deep)

Cod VIMAN, Vite autofilettante con manicotto (prof. 25mm)

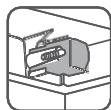

Code SPMAN, plug Ø 4 with sleeve (23 mm deep)

Cod SPMAN, Spina Ø 4 con manicotto (prof. 23mm)

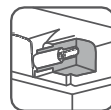

Code SPRAS, flush plug, Ø 4 (13.5 mm deep)

Cod SPRAS, Spina a raso Ø 4 (prof. 13.5mm)

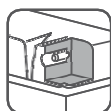

Code VIRAS, flush self-tapping screw (18 mm deep)

Cod VIRAS, Vite autofilettante a raso (prof. 18mm)

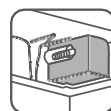

Classic wound transformer with ferromagnetic core, covered with thermosetting epoxy resin which gives it a metallic appearance and at the same time highly insulating. Produced for over 40 years in over 10 million pieces, are designed for ignition applications at 360°, from gas and oil burners to the high-pressure washers machines and anti-mosquito equipment, in addition to high-voltage and ozone generators. They are available in 4 product families depending on the power from the smaller Z, the small E, the standard S, up to the great power G. The principle of operation at 50 or 60 Hz makes it suitable for applications where the cable length are longer than 2m. Available in several versions of inlets and outlets combined with input voltages and output currents fully customizable.



Classico trasformatore avvolto con nucleo ferromagnetico, rivestito in resina epossidica termoindurente che gli conferisce un aspetto metallico ed al tempo stesso altamente isolante. Prodotto da oltre 40 anni in oltre 10 milioni di pezzi, sono progettati per applicazioni di accensione a 360° dai bruciatori a gas e Olio alle idropulitrici e zanzariere, oltre a generatori di alta tensione ed ozono. Sono disponibili in 4 famiglie di prodotto a seconda della potenza prodotta, dalla Z più piccola, la E piccola, la S standard, fino alla G di grande potenza. Il principio di funzionamento a 50 o 60 Hz lo rende adatto ad applicazioni dove la lunghezza dei cavi è superiore ai 2mt. Disponibile in numerose versioni di ingressi e uscite in combinazione con tensioni di ingresso ed uscita totalmente personalizzabili.

# ELECTRONIC TRANSFORMERS

TRASFORMATORI  
ELETTRONICI



10

Series	Type	Vin	Iout cc mA	ED	Output	Applications	page
						  	

## TRK ELECTRONIC TRANSFORMERS | TRASFORMATORE ELETTRONICO TRK



TRK1-20CVD	220-240V	20	100%	Grounded center		•	•	14
TRK1-20PCVD	220-240V	20	100%	Grounded pole	•		•	15
TRK1-30CVD	220-240V	30	100%	Grounded center		•	•	14
TRK1-30CHD	220-240V	30	100%	Grounded center		•	•	18
TRK1-30PCVD	220-240V	30	100%	Grounded pole	•		•	15
TRK2-35	220-240V	35	33% on 3'	Grounded center		•		14
TRK2-30PVD	220-240V	30	33% on 3'	Grounded pole	•			15
TRK2-30PFVD	220-240V	30	33% on 3'	Grounded pole	•			15
TRK2-30PVDUS	220-240V	30	33% on 3'	Grounded pole	•			15
TRK2-30PFVDUS	220-240V	30	33% on 3'	Grounded pole	•			15
TRK2-30PHD	220-240V	30	33% on 3'	Grounded pole	•			18
TRK2-40VD	220-240V	40	33% on 3'	Grounded center		•		14
TRK2-40HD	220-240V	40	33% on 3'	Grounded center		•		18
TRK2-40HK	220-240V	40	33% on 3'	Grounded center		•		16
TRK2-40HKL	220-240V	40	33% on 3'	Grounded center		•		16
TRK2-40PVD	220-240V	40	33% on 3'	Grounded pole	•			15
TRK2-40PHK	220-240V	40	33% on 3'	Grounded pole	•			17
TRK2-40PHKL	220-240V	40	33% on 3'	Grounded pole	•			17
TRK2-40SHK	220-240V	40	33% on 3'	Insulated		•		16
TRK2-40SVD	220-240V	40	33% on 3'	Insulated		•		14
TRK2-40PHD	220-240V	40	33% on 3'	Grounded center		•		18
TRK1-20CUVD	120V	20	100%	Grounded center		•		14
TRK1-20PCUVD	120V	20	100%	Grounded pole	•			15
TRK2-30PUVD	120V	26	33% on 3'	Grounded pole	•			15
TRK2-30PUFVD	120V	26	33% on 3'	Grounded pole	•			15
TRK2-30UVD	120V	30	33% on 3'	Grounded center		•		14

## TRJ ELECTRONIC TRANSFORMER | TRASFORMATORE ELETTRONICO TRJ





TRJ2-30VD	220-240V	21	33% su 3'	Grounded center		•		19
TRJ2-30PVD	220-240V	22	33% su 3'	Grounded pole	•			19
TRJ3-40CVD	220-240V	30	100%	Grounded center		•	•	20



Series	Type	Vin	Energy / Iout cc [mJ]	ED	Output	Applications	page
--------	------	-----	-----------------------	----	--------	--------------	------



**TRW CAPACITANCEDI SCHARGEI GNITER | TRASFORMATORE A SCARICA CAPACITIVA TRW**

	TRW1P2	220-240V	<b>20 mJ</b>	100%	Grounded center	•			24
	TRW1P2R	220-240V	<b>20 mJ</b>	100%	Grounded center	•			24
	TRW1P4	220-240V	<b>20 mJ</b>	100%	Grounded center	•			24
	TRW1P4R	220-240V	<b>20 mJ</b>	100%	Grounded pole	•			24
	TRW1S2M	220-240V	<b>20 mJ</b>	100%	Insulated	•			24
	TRW1S4	220-240V	<b>20 mJ</b>	100%	Insulated	•			24
	TRW2P2	220-240V	<b>20 mJ</b>	100%	Grounded center	•			25
	TRW2P4	220-240V	<b>20 mJ</b>	100%	Grounded center	•			25
	TRW2P4R	220-240V	<b>20 mJ</b>	100%	Grounded pole	•			25

**TRM ELECTRONIC TRANSFORMER | TRASFORMATORE ELETTRONICO TRM**

	TRM24-20PC	24 Vdc	<b>14</b>	100%	Grounded pole	•	•	•	21

**TRL POWER ELECTRONIC TRANSFORMERS | TRASFORMATORE ELETTRONICO DI POTENZA TRL**

	TRL12-30C	12 Vdc	<b>22</b>	100%	Grounded center		•	•	22
	TRL24-30C	24 Vdc	<b>22</b>	100%	Grounded center		•	•	22
	TRL12-30PC	12 Vdc	<b>22</b>	100%	Grounded pole	•		•	22
	TRL24-30PC	24 Vdc	<b>22</b>	100%	Grounded pole	•		•	22

**TRH POWER ELECTRONIC TRANSFORMERS | TRASFORMATORE ELETTRONICO DI POTENZA TRH**

	TRH2-30CU	120V	<b>30</b>	100%	Grounded center		•	•	23
	TRH2-30C	230V	<b>30</b>	100%	Grounded center		•	•	23
	TRH2-30CQ	400V	<b>30</b>	100%	Grounded center		•	•	23
	TRH2-60	230V	<b>40</b>	33% on 3'	Grounded center		•		23
	TRH2-40U	120V	<b>50</b>	33% on 3'	Grounded center		•		23







# INDUCTIVE TRANSFORMERS

TRASFORMATORI  
INDUTTIVI



12

Series	Type	Vin	Vout [kV]	Iout cc [mA]	ED	Output	Applications	page
							   	

## TRZ INDUCTIVE TRANSFORMER | TRASFORMATORE INDUTTIVO TRZ

	TRZ410CL	230V	2x2	<b>10</b>	100%	Grounded center			•		32
	TRZ510C	230V	2x2,5	<b>10</b>	100%	Grounded center			•		32
	TRZ4.509PC	230V	1x4,5	<b>9</b>	100%	Grounded pole			•		32





## TRE INDUCTIVE TRANSFORMER | TRASFORMATORE INDUTTIVO TRE

	TRE308C	230V	2x1,5	<b>8</b>	100%	Grounded center			•		26
	TRE510C	230V	2x2,5	<b>10</b>	100%	Grounded center			•		26
	TRE820	230V	2x4	<b>20</b>	19% on 3'	Grounded center	•	•			26
	TRE210PC	230V	1x2	<b>10</b>	100%	Grounded pole			•		25
	TRE410PC	230V	1x4	<b>10</b>	100%	Grounded pole	•				25
	TRE510PC	230V	1x5	<b>10</b>	100%	Grounded pole	•				25
	TRE820P	230V	1x8	<b>20</b>	19% on 3'	Grounded pole	•				25
	TRE820PISO	230V	1x8	<b>20</b>	19% on 3'	Insulated	•				25

## TRG INDUCTIVE TRANSFORMER | TRASFORMATORE INDUTTIVO TRG

	TRG1015C	230V	2x5	<b>15</b>	100%	Grounded center		•		•	30
	TRG1020C	230V	2x5	<b>20</b>	100%	Grounded center		•		•	30
	TRG1035	230V	2x5	<b>35</b>	25% on 4'	Grounded center		•		•	30
	TRG1035 US	120V	2x5	<b>35</b>	25% on 4'	Grounded center		•			30
	TRG1225	230V	2x6	<b>25</b>	25% on 4'	Grounded center		•			30
	TRG1230	230V	2x6	<b>30</b>	33% on 3'	Grounded center		•			30
	TRG1230	120V	2x6	<b>30</b>	25% on 4'	Grounded center		•			30
	TRG623PCUS	120V	1x6	<b>23</b>	100%	Grounded pole	•				31
	TRG820PC	230V	1x8	<b>20</b>	100%	Grounded pole	•				31
	TRG835P	230V	1x8	<b>35</b>	25% on 4'	Grounded pole	•				31
	TRG1020PC	230V	1x10	<b>20</b>	100%	Grounded pole	•				31
	TRG1035P	230V	1x10	<b>35</b>	25% on 4'	Grounded pole	•				31



Series	Type	Vin	Vout [kV]	Iout cc [mA]	ED	Output	Applications	page
							   	

**TRS INDUCTIVE TRANSFORMER | TRASFORMATORE INDUTTIVO TRS**



TRS513C	230V	2x2,5	<b>10</b>	100%	Grounded center			•	•	28
TRS812C	230V	2x4	<b>12</b>	100%	Grounded center		•		•	28
TRS815C	230V	2x4	<b>15</b>	100%	Grounded center				•	28
TRS818C	230V	2x4	<b>18</b>	100%	Grounded center		•		•	28
TRS820	230V	2x4	<b>20</b>	25% on 4'	Grounded center		•			28
TRS1020	230V	2x5	<b>20</b>	25% on 4'	Grounded center		•			28
TRS1020	230V	2x5	<b>20</b>	33% on 3'	Grounded center		•		•	28
TRS1030	230V	2x5	<b>30</b>	25% on 4'	Grounded center		•			28
TRS1220	230V	2x6	<b>20</b>	25% on 4'	Grounded center		•			28
TRS404PC	230V	1x4	<b>4</b>	100%	Grounded pole	•	•			29
TRS505PC	230V	1x5	<b>5</b>	100%	Grounded pole	•	•			29
TRS508PC	230V	1x5	<b>8</b>	100%	Grounded pole	•	•			29
TRS510PC	230V	1x5	<b>10</b>	100%	Grounded pole	•	•			29
TRS515PC	230V	1x5	<b>15</b>	100%	Grounded pole	•	•			29
TRS6.508PC	230V	1x6,5	<b>8</b>	100%	Grounded pole	•	•			29
TRS606PC	230V	1x6,5	<b>6</b>	100%	Grounded pole	•	•			29
TRS610PC	230V	1x6,5	<b>10</b>	100%	Grounded pole	•	•			29
TRS708PC	230V	1x7	<b>8</b>	100%	Grounded pole	•	•			29
TRS818PC	230V	1x8	<b>18</b>	100%	Grounded pole	•	•			29
TRS820P	230V	1x8	<b>20</b>	25% on 4'	Grounded pole	•	•			29
TRS723P US	120V	1x8	<b>23</b>	25% on 4'	Grounded pole	•	•			29
TRS820PISO	230V	1x8	<b>20</b>	33% on 3'	Insulated	•	•			29
TRS830P	230V	1x8	<b>30</b>	25% on 4'	Grounded pole	•	•			29
TRS1815C/IS	230V	1x2	<b>15</b>	100%	Insulated	•	•			29

# TRK<sub>VD</sub>

Vertical outlet | Plug D  
Uscite Verticali | Spina D



**2 POLES | 2 POL**



14

Technical drawing | Disegno tecnico [mm]

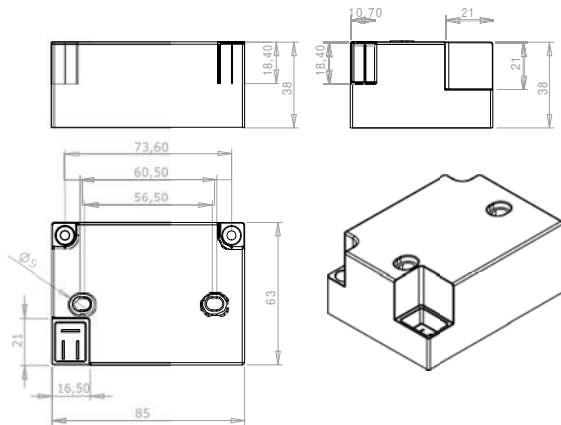

Inlet | Ingressi

Plug D | Presa per spina D

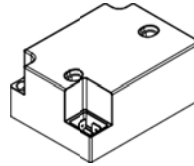

Outlet | Uscite

V plug, vertical output plug, Ø 4mm | Spina A.T. Ø 4 verticale V

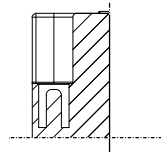

Type	Vin	Pin	Iout cc	Iout burn*	Vout	ED	Ta	Output	Note
<b>CONTINUOUS 100%   CONTINUI 100%</b>									
TRK1-20CVD	220-240V	30W	20 mA	12 mA	2x14 kV	100%	60°C	Grounded center	
TRK1-30CVD	230V	30W	30 mA	17 mA	2x12 kV	100%	60°C	Grounded center	
TRK1-20CUVD	120V	22W	20 mA	12 mA	2x14 kV	100%	60°C	Grounded center	
<b>INTERMITTENT   INTERMITTENTI</b>									
TRK2-35	220-240V	65W	35 mA	20 mA	2x10 kV	33% on 3'	60°C	Grounded center	
TRK2-40VD	220-240V	65W	40 mA	24 mA	2x10 kV	33% on 3'	60°C	Grounded center	
TRK2-40SVD**	220-240V	65W	40 mA	24 mA	15 kV	33% on 3'	60°C	Insulated	
TRK2-30UVD	120V	60W	30 mA	20 mA	2x12 kV	33% on 3'	60°C	Grounded center	

\*Current measured on the burner with 5mm spark gap, blowing air and suppressed cables | Condizioni di lavoro su bruciatore con puntine a 6mm in aria soffiata con cavi resistivi.

\*\*One pole shall be grounded. | Un polo deve essere messo a terra.

Applications | Applicazioni



Available certification | Certificazioni disponibili





Transformers of widely used standards, produced in many different versions, with different powers and suitable for all applications on the market inputs and outputs configurations. Available in intermittent and continuous version for gas and oil applications, it is available filtered or unfiltered (F).

Trasformatore standard di larga diffusione, prodotto in numerose versioni diverse, con potenze diverse e configurazioni ingressi ed uscite adatte a tutte le applicazioni sul mercato. Disponibile in versione intermittente e continuo per applicazioni a gas e gasolio, ed è possibile averlo filtrato o non filtrato (F).

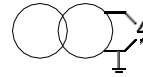

**1 POLE | 1 POLO**

**Technical drawing | Disegno tecnico [mm]**

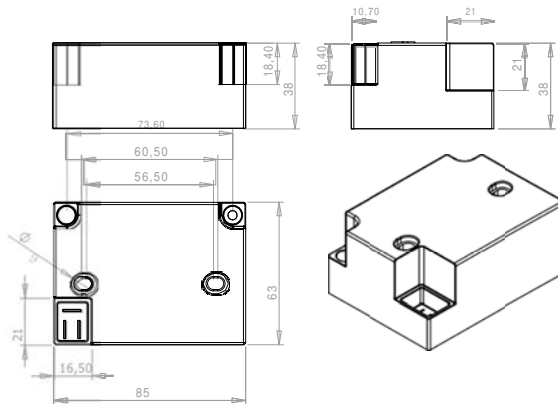

**Inlet | Ingressi**

**Plug D | Presa per spina D**

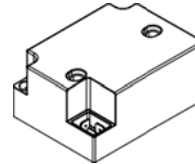

**Outlet | Uscite**

**V plug, vertical output plug, Ø 4 mm | Spina A.T. Ø 4 verticale V**

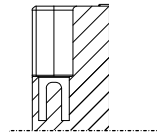

Type	Vin	Pin	Iout cc	Iout burn*	Vout	ED	Ta	Output	Note
<b>CONTINUOUS 100%   CONTINUI 100%</b>									
TRK1-20PCVD	220-240V	30W	20 mA	12 mA	1x15 kV	100%	60°C	Grounded pole	CE
TRK1-30PCVD	220-240V	30W	30 mA	17 mA	1x15 kV	100%	60°C	Grounded pole	CE
TRK1-20PCUVD	120V	30W	20 mA	12 mA	1x15 kV	100%	60°C	Grounded pole	CE
<b>INTERMITTENT   INTERMITTENTI</b>									
TRK2-30PVD	220-240V	63W	30 mA	20 mA	1x15 kV	33% on 3'	60°C	Grounded pole	CE
TRK2-30PFVD	220-240V	63W	30 mA	20 mA	1x15 kV	33% on 3'	60°C	Grounded pole	CE
TRK2-30PVDUS	230V	69W	30 mA	20 mA	1x15 kV	33% on 3'	60°C	Grounded pole	CE, C, RU, US
TRK2-30PFVDUS	230V	69W	30 mA	20 mA	1x15 kV	33% on 3'	60°C	Grounded pole	CE, C, RU, US
TRK2-40PVD	220-240V	65W	40 mA	24 mA	1x15 kV	33% on 3'	60°C	Grounded pole	CE
TRK2-30PUVD	120V	60W	36 mA	20 mA	1x15 kV	33% on 3'	60°C	Grounded pole	C, RU, US
TRK2-30PUFVD	120V	60W	36 mA	20 mA	1x15 kV	33% on 3'	60°C	Grounded pole	C, RU, US

\*Current measured on the burner with 5mm spark gap, blowing air and suppressed cables | Condizioni di lavoro su bruciatore con puntine a 6mm in aria soffiata con cavi resistivi.

**Applications | Applicazioni**



**Available certification | Certificazioni disponibili**



# TRK <sup>HK</sup>

Horizontal outlet | Plug K  
Uscite Orizzontali | Spina K



16 **2 POLES | 2 POL**

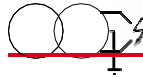

Technical drawing | Disegno tecnico [mm]

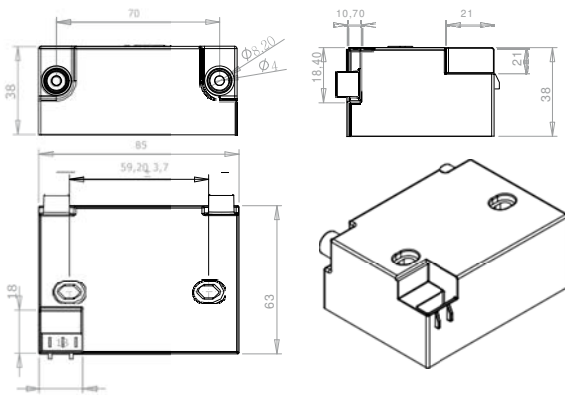

Inlet | Ingressi

Plug K | Presa per spina K

Plug K with L | Presa per spina K con terra su linguetta

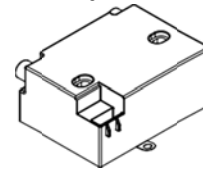
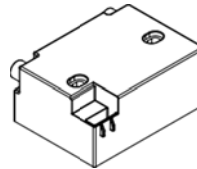

Outlet | Uscite

H plug, horizontal output plug, Ø 4 mm (13.5 mm deep) | Spina A.T. Ø 4 orizzontale H

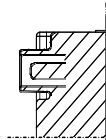

Type	Vin	Pin	Iout cc	Iout burn*	Vout	ED	Ta	Output	Note
<b>INTERMITTENT   INTERMITTENTI</b>									
TRK2-4CHK	220-240V	65W	40 mA	24 mA	2x10 kV	33% on 3'	60°C	Grounded center	
TRK2-4CHKL	220-240V	65W	40 mA	24 mA	2x10 kV	33% on 3'	60°C	Grounded center	
TRK2-4CSHK**	220-240V	65W	40 mA	24 mA	15 kV	33% on 3'	60°C	Insulated	

\*Current measured on the burner with 5mm spark gap, blowing air and suppressed cables | Condizioni di lavoro su bruciatore con puntine a 6mm in aria soffiata con cavi resistivi.  
\*\*One pole shall be grounded. | Un polo deve essere messo a terra.

Applications | Applicazioni



Available certification | Certificazioni disponibili



Transformers of widely used standards, produced in many different versions, with different powers and suitable for all applications on the market inputs and outputs configurations. Available in intermittent and continuous version for gas and oil applications.

Trasformatore standard di larga diffusione, prodotto in numerose versioni diverse, con potenze diverse e configurazioni ingressi ed uscite adatte a tutte le applicazioni sul mercato. Disponibile in versione intermittente e continuo per applicazioni a gas e gasolio.

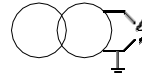

# 1 POLE | 1 POLO

### Technical drawing | Disegno tecnico [mm]

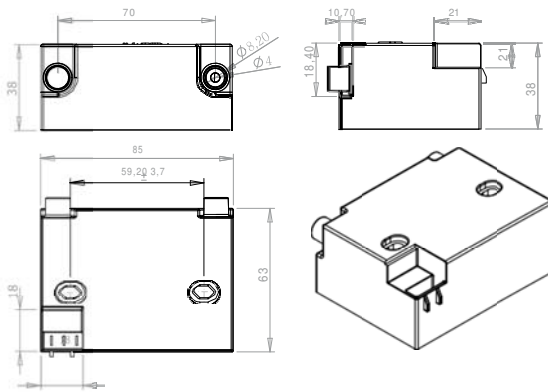

### Inlet | Ingressi

Plug K | Presa per spina K

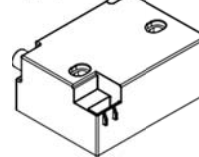

Plug K with L | Presa per spina K con terra su linguetta

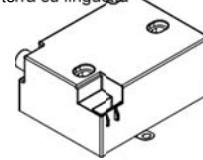

### Outlet | Uscite

H plug, horizontal output plug, Ø4 mm (13.5 mm deep) | Spina A.T. Ø 4 orizzontale H

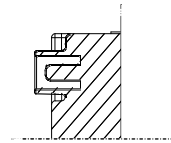

Type	Vin	Pin	Iout cc	Iout burn*	Vout	ED	Ta	Output	Note
<b>INTERMITTENT   INTERMITTENTI</b>									
TRK2-40PHK	220-240V	65W	40 mA	24 mA	1x15 kV	33% on 3'	60°C	Grounded pole	
TRK2-40PHKL	220-240V	65W	40 mA	24 mA	1x15 kV	33% on 3'	60°C	Grounded pole	

\*Current measured on the burner with 5mm spark gap, blowing air and suppressed cables | Condizioni di lavoro su bruciatore con puntine a 6mm in aria soffiata con cavi resistivi.





# TRK<sub>HD</sub>

Horizontal outlet | Plug D  
Uscite Orizzontali | Spina D



## 2 POLES | 2 POLI

18



Technical drawing | Disegno tecnico [mm]

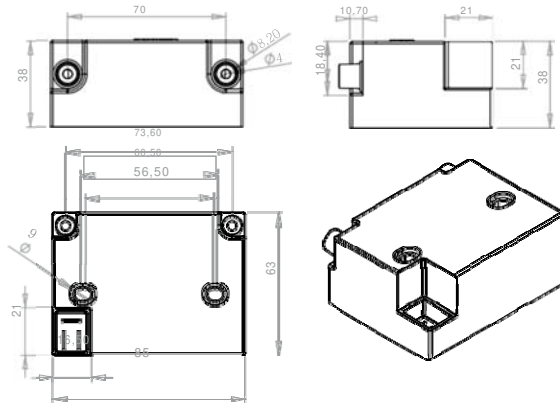

Inlet | Ingressi

Plug D | Presa per spina D

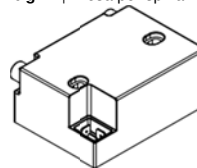

Outlet | Uscite

H plug, horizontal output plug, Ø4 mm (13.5 mm deep) | Spina A.T. Ø 4 orizzontale H



**STANDARD**

Type	Vin	Pin	Iout cc	Iout burn*	Vout	ED	Ta	Output	Note
<b>CONTINUOUS 100%   CONTINUI 100%</b>									
TRK1-30CHD	220-240V	30W	30 mA	17 mA	2x12 kV	100%	60°C	Grounded center	
<b>INTERMITTENT   INTERMITTENTI</b>									
TRK2-40HD	220-240V	65W	40 mA	24 mA	2x10 kV	33% on 3'	60°C	Grounded center	CE
*Current measured on the burner with 5mm spark gap, blowing air and suppressed cables   Condizioni di lavoro su bruciatore con puntine a 6mm in aria soffiata con cavi resistivi.									CE

## 1 POLE | 1 POLO



Technical drawing | Disegno tecnico [mm]

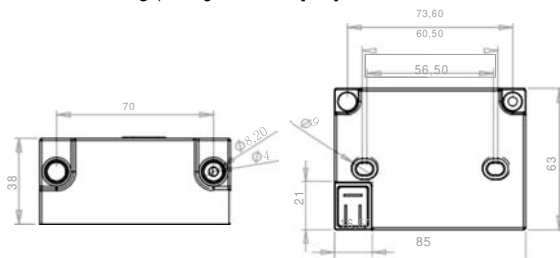

Inlet | Ingressi

Plug D | Presa per spina D

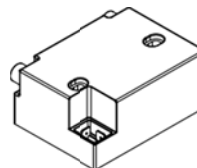

Outlet | Uscite

H plug, horizontal output plug, Ø 4 mm (13.5 mm deep) | Spina A.T. Ø 4 orizzontale H

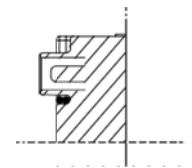

Type	Vin	Pin	Iout cc	Iout burn*	Vout	ED	Ta	Output	Note
<b>INTERMITTENT   INTERMITTENTI</b>									
TRK2-30PHD	220-240V	63W	30 mA	20 mA	1x15 kV	33% on 3'	60°C	Grounded pole	CE
TRK2-40PHD	220-240V	65W	40 mA	24 mA	1x15 kV	33% on 3'	60°C	Grounded pole	CE

\*Current measured on the burner with 5mm spark gap, blowing air and suppressed cables | Condizioni di lavoro su bruciatore con puntine a 6mm in aria soffiata con cavi resistivi.

Applications | Applicazioni

Available certification | Certificazioni disponibili

Transformer 4th generation and new concept, which incorporates all the experience and knowledge, accumulated in over 20 years of electronic design and production, is able to combine excellent power performance at a very affordable price.

Trasformatore di 4° generazione e nuova concezione che ingloba tutte le esperienze e conoscenze accumulate in oltre 20 anni di progettazione e produzione elettronica, riesce a coniugare ottime prestazioni di accensione ad un prezzo molto contenuto.



# TRJ



## 2 POLES | 2 POLI

### Technical drawing | Disegnotecnico [mm]

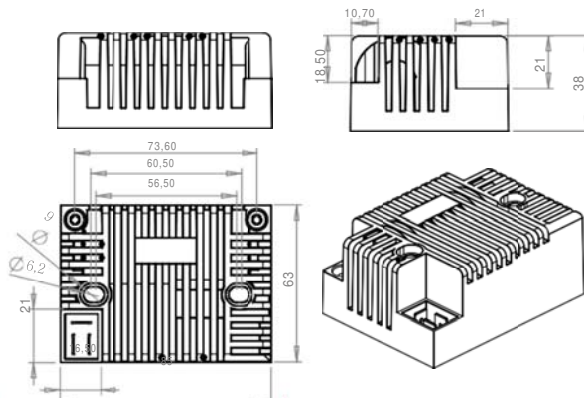

### Inlet | Ingressi

Plug K | Presa per spina K

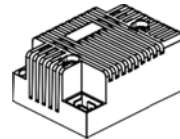

### Outlet | Uscite

V plug, vertical output plug, Ø 4 mm | Spina A.T. Ø 4 verticale V

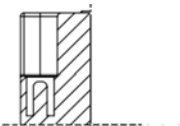

**BEST PRICE**

Type	Vin	Pin	Ioutcc	Ioutburn*	Vout	ED	Ta	Output	Note
<b>INTERMITTENT   INTERMITTENTI</b>									
TRJ2-30VD	220-240V	65W	35 mA	21 mA	2x10 kV	33% su 3'	60°C	Grounded center	CE

\* Current measured on the burner with 5mm spark gap, blowing air and suppressed cables | Condizioni di lavoro su bruciatore con puntine a 6mm in aria soffiata con cavi resistivi.



## 1 POLE | 1 POLO

### Technical drawing | Disegno tecnico [mm]

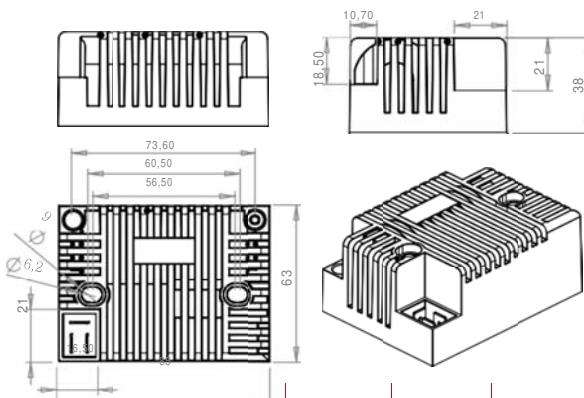

### Inlet | Ingressi

Plug K | Presa per spina K

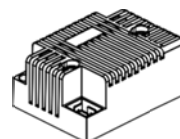

### Outlet | Uscite

V plug, vertical output plug, Ø 4 mm | Spina A.T. Ø 4 verticale V

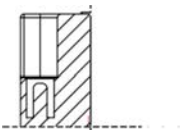

Type	Vin	Pin	Iout cc	Iout burn*	Vout	ED	Ta	Output	Note
<b>INTERMITTENT   INTERMITTENTI</b>									
TRJ2-30PVD	220-240V	63W	30 mA	22 mA	1x15 kV	33% su 3'	60°C	Grounded pole	CE

\* Current measured on the burner with 5mm spark gap, blowing air and suppressed cables | Condizioni di lavoro su bruciatore con puntine a 6mm in aria soffiata con cavi resistivi.

### Applications | Applicazioni



### Available certification | Certificazioni disponibili



# TRJ<sub>3</sub>

Vertical outlet | Plug D  
Uscite Verticali | Spina D



The power of an intermittent transformer that adapt it self at an eventual continuous duty.

La potenza di un trasformatore intermittente che si adatta ad un eventuale funzionamento continuo.

## 2 POLES | 2 POLI



20

### Technical drawing | Disegno tecnico [mm]

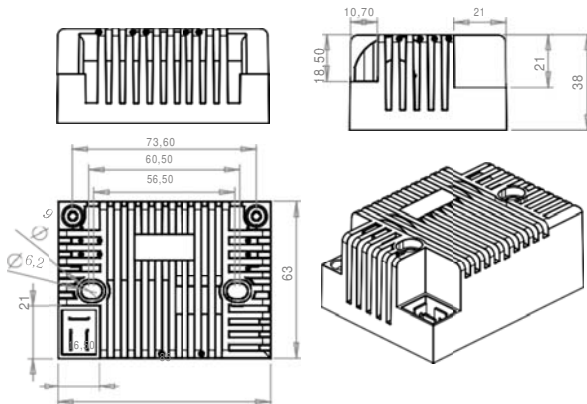

### Inlet | Ingressi

Plug D | Presa per spina D

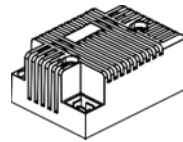

### Outlet | Uscite

V plug, vertical output plug, Ø 4mm | Spina A.T. Ø 4 verticale V

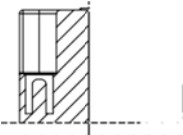

Type	Vin	Pin	I out cc	I out burn*	Vout	ED	Ta	Output	Note
<b>CONTINUOUS 100%   CONTINUI 100%</b>									
TRJ3-40CVD	220-240V	65W	30 mA	26-18 mA	2x14 kV	100%	60°C	Grounded center	CE

\* Current measured on the burner with 5mm spark gap, blowing air and suppressed cables | Condizioni di lavoro su bruciatore con puntine a 6mm in aria soffiata con cavi resistivi.

Transformer with a sophisticated temperature control able to take advantage of the environmental conditions to maximize the benefits provided, as long as the temperatures or duty cycles do not exceed certain conditions, the transformer provides the maximum current of 26mA, for example in the event of ignition in cold climates or after long periods of inactivity. In any case guarantees a service to 100% continuous with actual 18mA up to 60°C ambient temperature. It can be applied in any application that has very tight insertion cycles of always providing the maximum power available and self-limiting only in extreme environmental conditions.

Trasformatore con un controllo in temperatura sofisticato in grado di sfruttare le condizioni ambientali per massimizzare le prestazioni fornite, finché le temperature o i duty cycles non superano certe condizioni, il trasformatore fornisce la massima corrente di 26mA. Per esempio in caso di accensioni in climi freddi dopo lunghi periodi di inattività, in ogni caso garantisce un servizio al 100% continuo con 18mA effettivi fino a 60°C di temperatura ambiente. In applicazioni con cicli di inserzione molto stretti fornisce sempre la massima potenza disponibile, auto limitandosi solo in condizioni ambientali estreme.

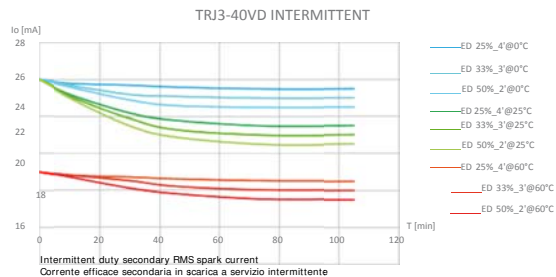
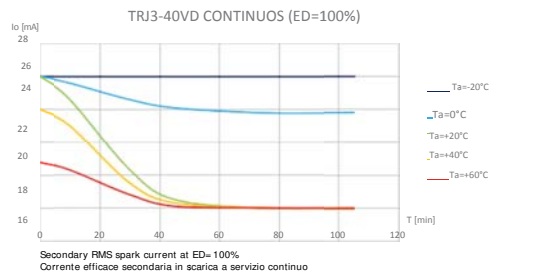

### Applications | Applicazioni



### Available certification | Certificazioni disponibili



24 Vdc igniter of compact size with 1 pole, designed for gas applications which do not require high power levels and still fed in systems with portable generators where there is no power line.

Trasformatore a 24 Vdc ad un polo di dimensioni compatte, pensato per applicazioni gas dove non sono richieste potenze elevate e comunque alimentato in impianti con generatori portatili dove non è

presente la linea elettrica.



# TRM

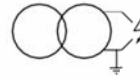

**1 POLE | 1 POLO**<sub>21</sub>

**Technical drawing | Disegno tecnico [mm]**

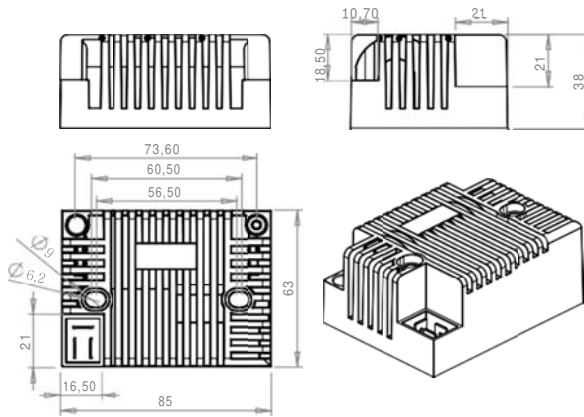

**Inlet | Ingressi**

**Plug K | Presa per spina K**

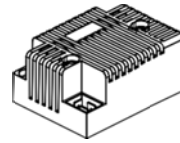

**24Vdc  
MIDDLE  
POWER**

**Outlet | Uscite**

**V plug, vertical output plug, Ø 4mm | Spina A.T. Ø 4 verticale V**

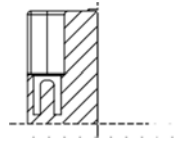

Type	Vin	Pin	Iout cc	Iout burn*	Vout	ED	Ta	Output	Note
<b>CONTINUOUS 100%   CONTINUI 100%</b>									
TRM24-20PCVD	24Vdc	40W	20 mA	14 mA	1x15 kV	100%	60° C	Grounded pole	CE

\* Current measured on the burner with 5mm spark gap, blowing air and suppressed cables | Condizioni di lavoro su bruciatore con puntine a 6mm in aria soffiata con cavi resistivi.

**Applications | Applicazioni**



**Available certification | Certificazioni disponibili**



# TRL

Vertical outlet | Plug D  
Uscite Verticali | Spina D



High power transformers and sophisticated technology capable of meeting the most stringent requirements demanding high power and extension of the limits of use in extreme temperatures, in off shore and portable systems with supply voltage 12 and 24 Vdc, continuous duty for oil and gas applications .

Trasformatori di alta potenza e tecnologia sofisticata in grado di soddisfare le esigenze più stringenti che chiedono grande potenza ed estensione dei limiti di impiego a temperature estreme in impianti off shore e portatili con tensione di alimentazione a 12 e 24 Vdc a servizio continuo per applicazioni gasolio e gas.

## 2 POLES | 2 POLI

22

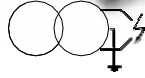

Technical drawing | Disegno tecnico [mm]

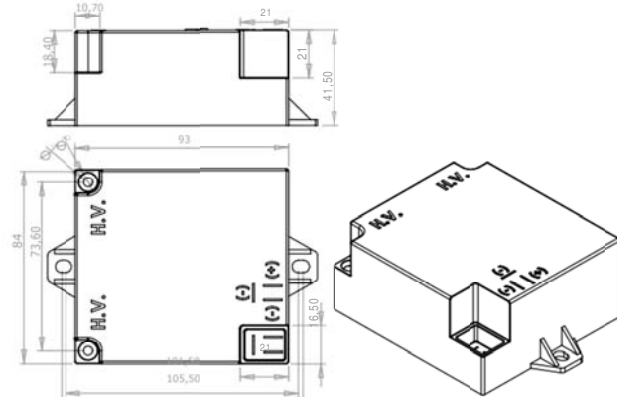

Inlet | Ingressi

Plug D | Presa per spina D

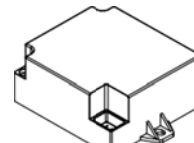

Outlet | Uscite

V plug, vertical output plug, Ø 4mm | Spina A.T. Ø 4 verticale V

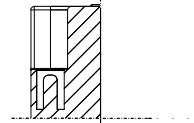

Type	Vin	Pin	I out cc	I out burn*	Vout	ED	Ta	Output	Note
TRL12-30C	12Vdc	80W	30 mA	22 mA	2x12kV	100%	60°C	Grounded center	CE
TRL24-30C	24Vdc	80W	30 mA	22 mA	2x12kV	100%	60°C	Grounded center	CE

\*Current measured on the burner with 5mm spark gap, blowing air and suppressed cables | Condizioni di lavoro su bruciatore con puntine a 6mm in aria soffiata con cavi resistivi.

## 1 POLE | 1 POLO

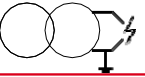

Technical drawing | Disegno tecnico [mm]

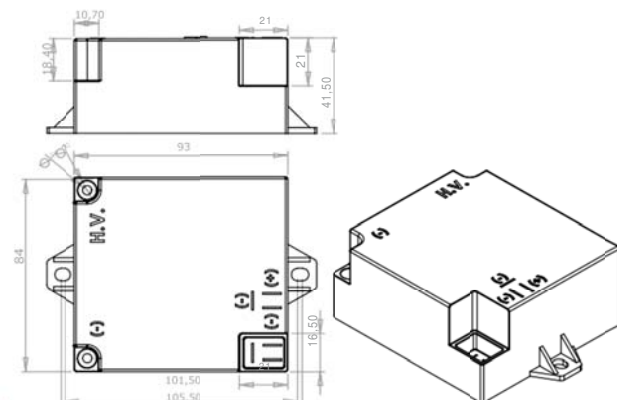

Inlet | Ingressi

Pres a per spina D | Plug D

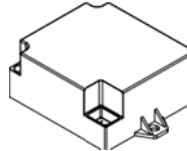

Outlet | Uscite

V plug, vertical output plug, Ø 4mm | Spina A.T. Ø 4 verticale V

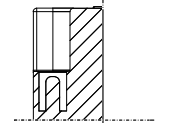

Type	Vin	Pin	I out cc	I out burn*	Vout	ED	Ta	Output	Note
TRL12-30PC	12Vdc	80W	30 mA	22 mA	1x15kV	100%	60°C	Grounded pole	
TRL24-30PC	24Vdc	80W	30 mA	22 mA	1x15kV	100%	60°C	Grounded pole	

\*Current measured on the burner with 5mm spark gap, blowing air and suppressed cables | Condizioni di lavoro su bruciatore con puntine a 6mm in aria soffiata con cavi resistivi.

Applications | Applicazioni



Available certification | Certificazioni disponibili





High power transformers and sophisticated technology able to meet the most stringent requirements that ask great power and extension of the limits of use at extreme temperatures. The transformers of this series are available in both continuous and intermittent service and supply voltages for all world markets from 120 to 400V.

Trasformatori di alta potenza e tecnologia sofisticata in grado di soddisfare esigenze più stringenti che chiedono grande potenza ed estensione dei limiti di impiego a temperature estreme. I questa serie di trasformatori sono disponibili sia a servizio continuo che intermittente e con tensioni di alimentazione per tutti i mercati mondiali da 120 a 400V.



# TRH

Vertical outlet | Plug D  
Uscite Verticali | Spina D

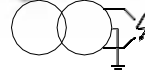

**2 POLES | 2 POLI**

**Technical drawing | Disegno tecnico [mm]**

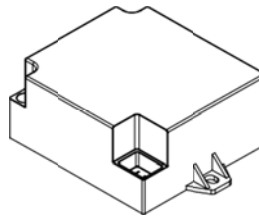
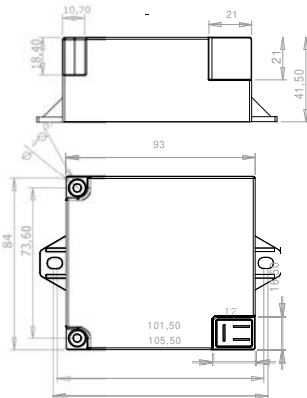

**Inlet | Ingressi**

**Plug D | Presa per spina D**

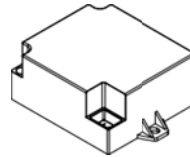

**Outlet | Uscite**

**V plug, vertical output plug, Ø 4 mm | Spina A.T. Ø 4 verticale V**

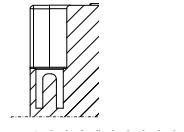

Type	Vin	Pin	Iout cc	Iout burn*	Vout	ED	Ta	Output	Note
<b>CONTINUOUS 100%   CONTINUI 100%</b>									
TRH2-30CU	120V	70W	30 mA	25 mA	2x12 kV	100%	60°C	Grounded center	CE
TRH2-30C	230V	60W	30 mA	25 mA	2x12 kV	100%	60°C	Grounded center	CE
TRH2-30CQ	400V	60W	30 mA	25 mA	2x12 kV	100%	60°C	Grounded center	CE
<b>INTERMITTENT   INTERMITTENTI</b>									
TRH2-60	230V	100W	50 mA	30 mA	2x12 kV	33% on 3'	60°C	Grounded center	CE
TRH2-40U	120V	90W	40 mA	30 mA	2x12 kV	33% on 3'	60°C	Grounded center	CE

**Applications | Applicazioni**



**Available certification | Certificazioni disponibili**



# TRW 1



Ignition transformer with capacitive discharge technology for applications in condensing boilers and atmospheric gas burners. Developed to produce more power to the classics on board lighters, filtered against electromagnetic interference and available with output for mono-electrode flame detection.

24

## 2 POLES | 2 POLI

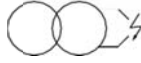

One pole shall be grounded. | Un polo deve essere messo a terra.

### Technical drawing | Disegno tecnico [mm]

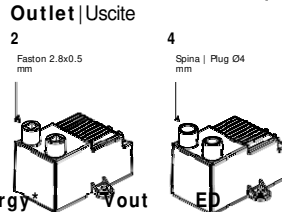
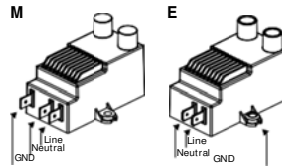
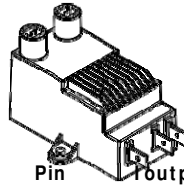
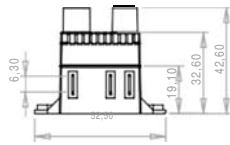
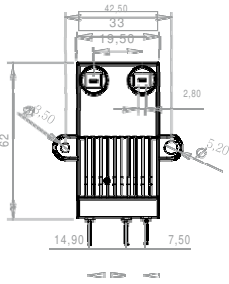

**CONDENSING BOILERS**

Type	Vin	Pin	Iout pick	Energy*	Vout	ED	Ta	Output	Note
TRW1S2E	220-240V	5W	800mA	20 mJ	15 kV	100%	60°C	Insulated	
TRW1S2M	220-240V	5W	800mA	20 mJ	15 kV	100%	60°C	Insulated	
TRW1S4E	220-240V	5W	800mA	20 mJ	15 kV	100%	60°C	Insulated	CE

\*Measured on 2k ohm resistor. | Misure effettuate su resistenze da 2k ohm.

## 1 POLE | 1 POLO



### Technical drawing | Disegno tecnico [mm]

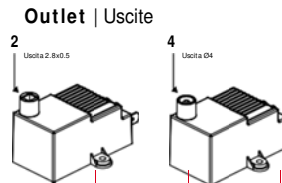
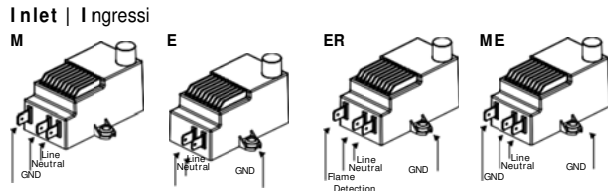
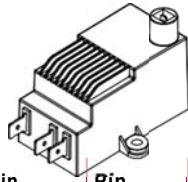
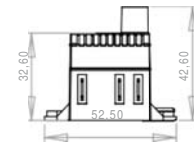
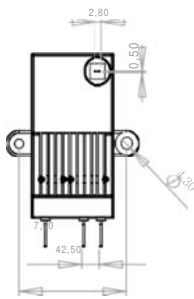

Type	Vin	Pin	Iout pick	Energy*	Vout	ED	Ta	Output	Note
TRW1P2M	220-240V	5W	800mA	20 mJ	1x15 kV	100%	60°C	Grounded pole	CE
TRW1P2E	220-240V	5W	800mA	20 mJ	1x15 kV	100%	60°C	Grounded pole	CE
TRW1P2ER	220-240V	5W	800mA	20 mJ	1x15 kV	100%	60°C	Grounded pole	CE
TRW1P2ME	220-240V	5W	800mA	20 mJ	1x15 kV	100%	60°C	Grounded pole	CE
TRW1P4M	220-240V	5W	800mA	20 mJ	1x15 kV	100%	60°C	Grounded pole	CE
TRW1P4E	220-240V	5W	800mA	20 mJ	1x15 kV	100%	60°C	Grounded pole	CE
TRW1P4ER	220-240V	5W	800mA	20 mJ	1x15 kV	100%	60°C	Grounded pole	CE
TRW1P4ME	220-240V	5W	800mA	20 mJ	1x15 kV	100%	60°C	Grounded pole	CE

\*Current measured on the burner with 5mm spark gap, blowing air and suppressed cables | Condizioni di lavoro su bruciatore con puntine a 6mm in aria soffiata con cavi resistivi.

### Applications | Applicazioni

### Available certification | Certificazioni disponibili



Trasformatore d'accensione con tecnologia a scarica capacitiva per applicazioni in caldaie a condensazione e o bruciatori a gas atmosferici. Sviluppato per produrre una potenza superiore ai classici accenditori a bordo scheda, filtrato contro i disturbi EMC e disponibile con uscita per rivelazione di fiamma mono-elettrodo.

# TRW<sub>2</sub>

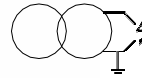

1 POLE | 1 POLO

**Technical drawing** | Disegnotecnico [mm]

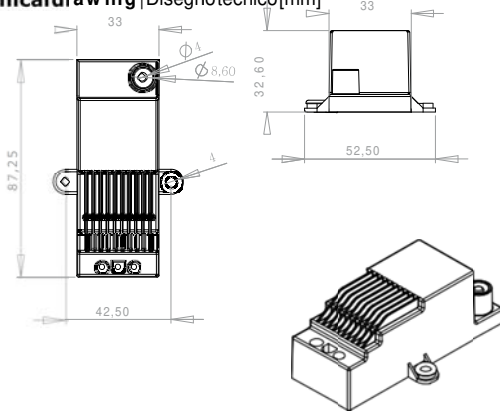

**Inlet** | Ingressi

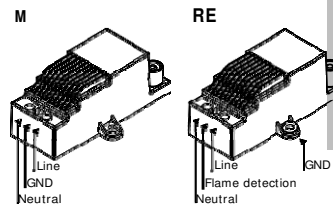

**CONDENSING BOILERS**

**Outlet** | Uscite

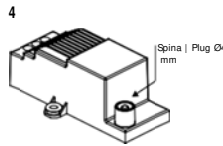

Type	Vin	Pin	Iout pick	Energy*	Vout	ED	Ta	Output	Note
TRW2P4M	220-240V	5W	800mA	20 mJ	1x15 kV	100%	60°C	Grounded pole	CE
TRW2P4RE	220-240V	5W	800mA	20 mJ	1x15 kV	100%	60°C	Grounded pole	CE

\*Mesured on 2k ohm resistor. | Misure effettuate su resistenze da 2k ohm.

**Applications** | Applicazioni



**Available certification** | Certificazioni disponibili



# TRE

26 **2 POLES | 2 POL** 

Technical drawing | Disegno tecnico [mm]

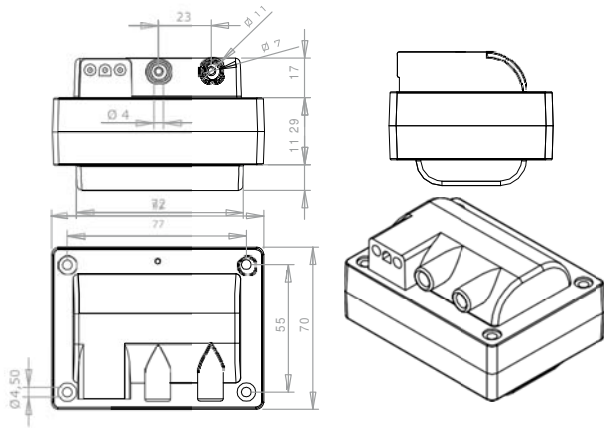

Standard buried cable L=380mm  
Cavo annegato standard L=380mm

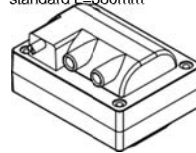

COFI plug  
PresaperospinaCofi

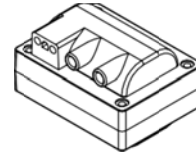

Triangle plug  
PresaperospinaTriangolo

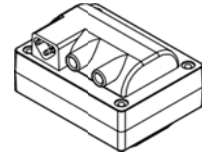

Outlet | Uscite  
Cod:SPRO

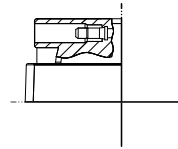

Cod:VI RAS

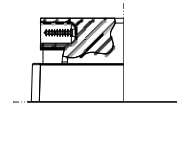

Cod:SPRAS

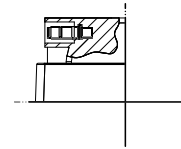

Type	Vin	Freq	Vout	Iout	ED	Output	Note
<b>CONTINUOUS 100%   CONTINUI 100%</b>							
TRE308C	230V	50Hz	2x1,5 kV	8 mA	100%	Grounded center	
TRE510C	230V	50Hz	2x2,5 kV	10 mA	100%	Grounded center	
<b>INTERMITTENT   INTERMITTENTI</b>							
TRE820	230V	50Hz	2x4 kV	20 mA	19% on 3'	Grounded center	

Applications | Applicazioni



Available certification | Certificazioni disponibili

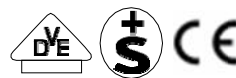

Small dimension transformer, it achieves the same performances of medium size transformers with lower costs, largely used for oil and gas burners, available with the secondary insulated for flame detection by ionization of the flame. It can also be applied to anti-mosquito equipment or ozone generators.

Il più piccolo della gamma: riesce a raggiungere le medesime prestazioni di accensione di alcuni trasformatori di dimensioni medie, ma a costi decisamente ridotti. Tale risultato è il frutto di una ricerca spinta sui materiali, che ha consentito una buona riduzione di ingombro.

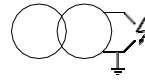

# 1 POLE | 1 POLO

### Technical drawing | Disegno tecnico [mm]

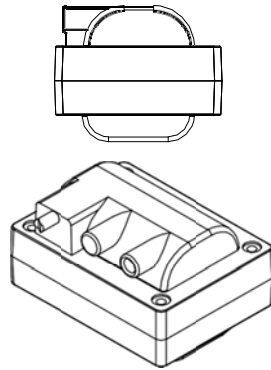
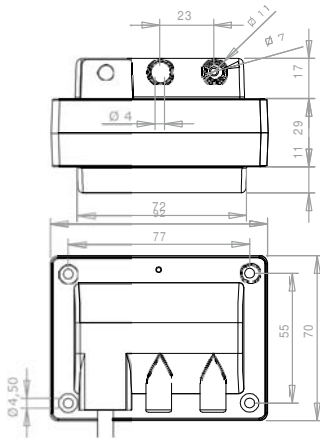

### Inlet | Ingressi

**Standard buried cable L= 380 mm**  
Cavo annegato standard L=380mm

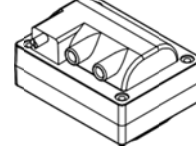

**COFI plug**  
Presa per spina Cofi

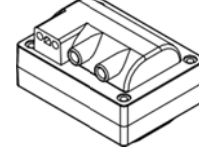

**Triangle plug**  
Presa per spina Triangolo

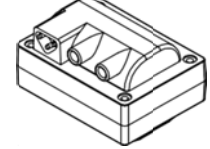

### Outlet | Uscite

Cod: SPRO

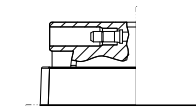

Cod: VIRAS

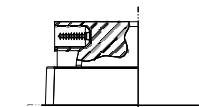

Cod: SPRAS

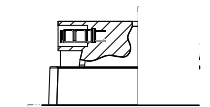

Type	Vin	Freq	Vout	Iout	ED	Output	Note
<b>CONTINUOUS 100%   CONTINUI 100%</b>							
TRE210PC	230V	50Hz	1x2 kV	10 mA	100%	Grounded pole	CE
TRE410PC	230V	50Hz	1x4 kV	10 mA	100%	Grounded pole	CE
TRE510PC	230V	50Hz	1x5 kV	10 mA	100%	Grounded pole	CE
TRE610PC	230V	50Hz	1x6 kV	10 mA	100%	Grounded pole	CE
<b>INTERMITTENT   INTERMITTENTI</b>							
TRE820P	230V	50Hz	1x8 kV	20 mA	19% on 3'	Grounded pole	DE S CE
<b>INSULATED   ISOLATO*</b>							
TRE510PCISO	230V	50Hz	1x5 kV	10 mA	100%	Insulated	CE
TRE515PISO	230V	50Hz	1x5 kV	15 mA	100%	Insulated	CE
TRE820PISO	230V	50Hz	1x8 kV	20 mA	19% on 3'	Insulated	CE

\*Transformers used with control box designed for igniting and flame detecting. | Trasformatori adatti all'uso con apparecchiature progettate per l'accensione e la rilevazione monoelettrodo.

### Applications | Applicazioni



### Available certification | Certificazioni disponibili





# TRS

28

## 2 POLES | 2 POL

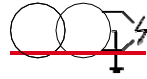

### Technical drawing | Disegno tecnico [mm]

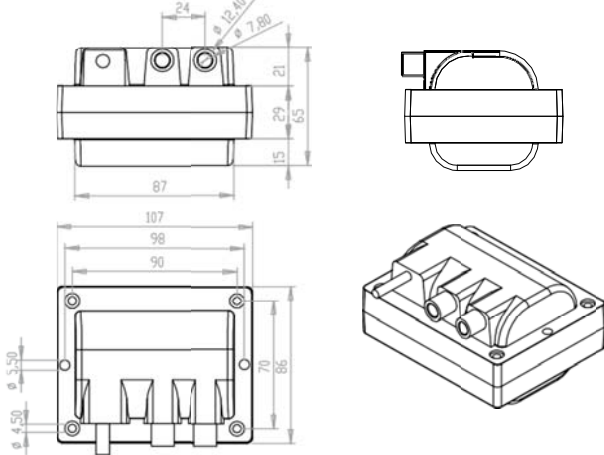

### Inlet

Standard buried cable  
Cavo annegato standard

COFI plug  
Presa perspina Cofi

Triangle plug  
Presa spina Triangolo

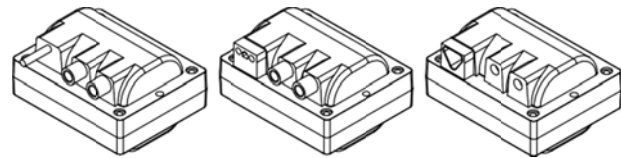

### Outlet | Uscite

Cod: SPRO

Cod: VIRAS

Cod: SPRAS

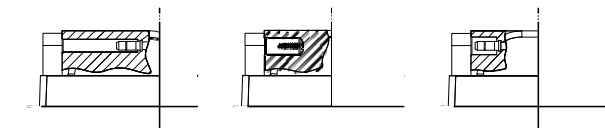

Cod: SPMAN

Cod: SP

Cod: VIMAN

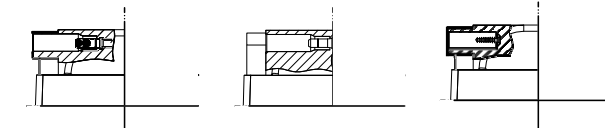

Type	Vin	Freq	Vout	Iout	ED	Output	Note
------	-----	------	------	------	----	--------	------

## CONTINUOUS 100% | CONTINUI 100%

TRS513C	230V	50Hz	2x2,5 kV	10 mA	100%	Grounded center	
TRS810C	230V	50Hz	2x4 kV	10 mA	100%	Grounded center	
TRS812C	230V	50Hz	2x4 kV	12 mA	100%	Grounded center	
TRS815C	230V	50Hz	2x4 kV	15 mA	100%	Grounded center	
TRS818C	230V	50Hz	2x4 kV	18 mA	100%	Grounded center	

## INTERMITTENT | INTERMITTENTI

TRS820	230V	50Hz	2x4 kV	20 mA	25% on 4'	Grounded center	
TRS1020	230V	50Hz	2x5 kV	20 mA	25% on 4'	Grounded center	
TRS1020	230V	50Hz	2x5 kV	20 mA	33% on 3'	Grounded center	
TRS1030	230V	50Hz	2x5 kV	30 mA	25% on 4'	Grounded center	
TRS1220	230V	50Hz	2x6 kV	20 mA	25% on 4'	Grounded center	

### Applications | Applicazioni



### Available certification | Certificazioni disponibili



Medium-size inductive transformer, suitable for all kinds of gas and oil burners, where continuous or intermittent power and achievement of higher voltages and currents are required. This serie is available in a great number of variations. It suits very different uses such as burners, high-pressure cleaners, anti-mosquito electric equipment and ionizers.

Trasformatore induttivo di dimensioni medie adatto a tutti i tipi di bruciatore a gas e a gasolio, dove è richiesta una potenza continua o intermittente e il raggiungimento di tensioni e correnti più elevate. Impieghi: bruciatori, idropultrici, zanzariere, ionizzatori.

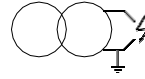

# 1 POLE | 1 POLO

### Technical drawing | Disegno tecnico [mm]

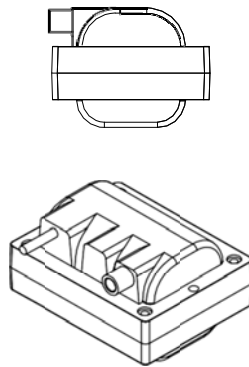
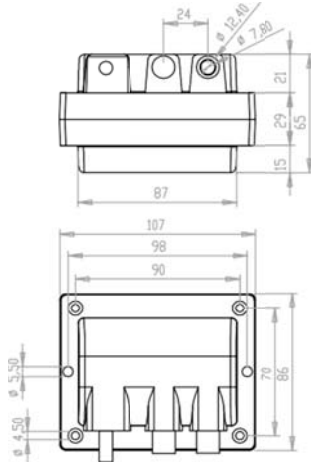

### Inlet | Ingressi

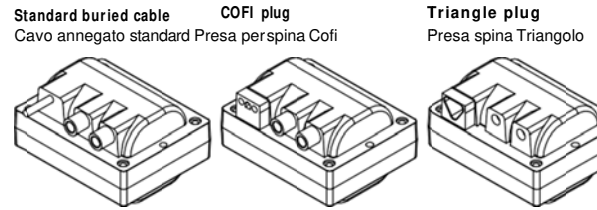

### Outlet | Uscite

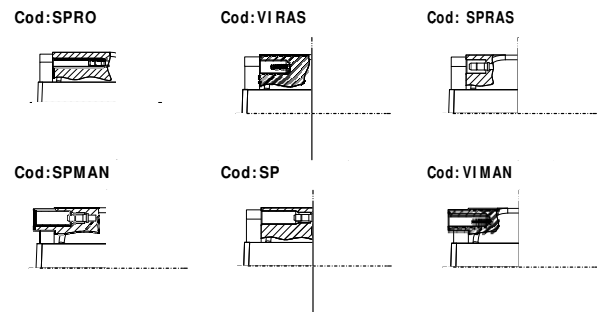

Type	Vin	Freq	Vout	Iout	ED	Output	Note
<b>CONTINUOUS 100%   CONTINUI 100%</b>							
TRS404PC	230V	50Hz	1x4 kV	4 mA	100%	Grounded pole	€
TRS505PC	230V	50Hz	1x5 kV	5 mA	100%	Grounded pole	€
TRS508PC	230V	50Hz	1x5 kV	8 mA	100%	Grounded pole	€
TRS510PC	230V	50Hz	1x5 kV	10 mA	100%	Grounded pole	€
TRS515PC	230V	50Hz	1x5 kV	15 mA	100%	Grounded pole	€
TRS6.508PC	230V	50Hz	1x6,5 kV	8 mA	100%	Grounded pole	€
TRS606PC	230V	50Hz	1x6,5 kV	6 mA	100%	Grounded pole	€
TRS610PC	230V	50Hz	1x6,5 kV	10 mA	100%	Grounded pole	€
TRS708PC	230V	50Hz	1x7 kV	8 mA	100%	Grounded pole	€
TRS818PC	230V	50Hz	1x8 kV	18 mA	100%	Grounded pole	€
TRS1815C/IS	230V	50Hz	1x2 kV	15 mA	100%	Grounded pole	€

### INTERMITTENT | INTERMITTENTI

TRS820P	230V	50Hz	1x8 kV	20 mA	25% on 4'	Grounded pole	€
TRS723P US	120V	60Hz	1x8 kV	23 mA	25% on 4'	Grounded pole	€
TRS830P	230V	50Hz	1x8 kV	30 mA	25% on 4'	Grounded pole	€
TRS820PI SO*	230V	50Hz	1x8 kV	20 mA	33% on 3'	Insulated	€

\* Transformers used with control box designed for igniting and flame detecting. | Trasformatori adatti all'uso con apparecchiature progettate per l'accensione e la rilevazione mono-elettrodo.

**Applications | Applicazioni**

**Available certification | Certificazioni disponibili**

# TRG



## 2 POLES | 2 POLI

30



### Technical drawing | Disegnotecnico [mm]

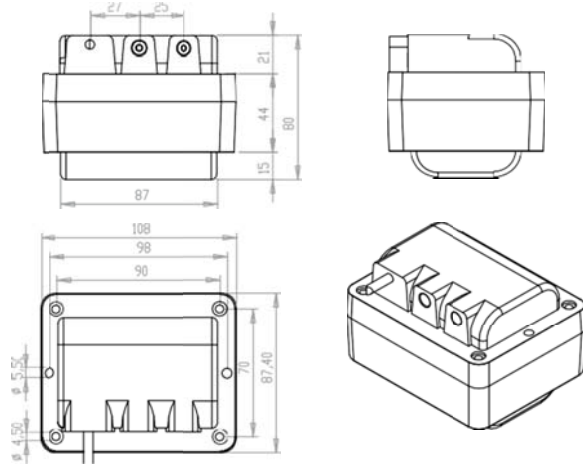

### Inlet | Ingressi

Standard buried cable  
Cavo annegato standard

COFI plug

Presa perspina Cofi

Triangle plug

Presa spina Triangolo

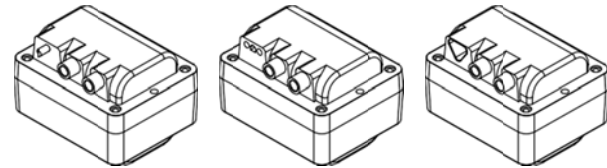

### Outlet | Uscite

Cod: SP

Cod: VIMAN

Cod: SPRAS

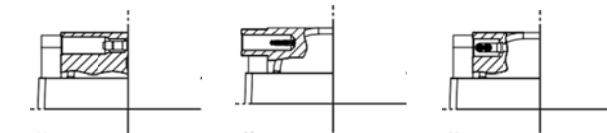

Cod: SPMAN

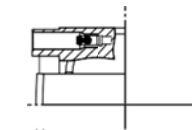

Type	Vin	Freq	Vout	Iout	ED	Output	Note
<b>CONTINUOUS 100%   CONTINUI 100%</b>							
TRG1015C	230V	50Hz	2x5 kV	15 mA	100%	Grounded center	
TRG1020C	230V	50Hz	2x5 kV	20 mA	100%	Grounded center	
<b>INTERMITTENT   INTERMITTENTI</b>							
TRG1035	230V	50Hz	2x5 kV	35 mA	25% on 4'	Grounded center	
TRG1035 US	120V	60Hz	2x5 kV	35 mA	25% on 4'	Grounded center	
TRG1225	230V	50Hz	2x6 kV	25 mA	25% on 4'	Grounded center	
TRG1230	230V	50Hz	2x6 kV	30 mA	33% on 3'	Grounded center	
TRG1230	120V	60Hz	2x6 kV	30 mA	25% on 4'	Grounded center	

### Applications | Applicazioni



### Available certification | Certificazioni disponibili



Large-size inductive transformer, suitable for large-flow and heavy fuel burners, where continuous power and higher voltages or currents are required. The versions of this range are suitable for use in large-size transformers and industrial high-pressure cleaners.

Trasformatore induttivo di grandi dimensioni adatto a bruciatori di grande portata e per combustibili pesanti, dove è richiesta una elevata potenza continua e il raggiungimento di tensioni o correnti più alte. Adatto anche alle grandi idropultrici industriali.

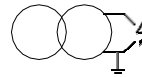

# 1 POLE | 1 POLO

### Technical drawing | Disegno tecnico [mm]

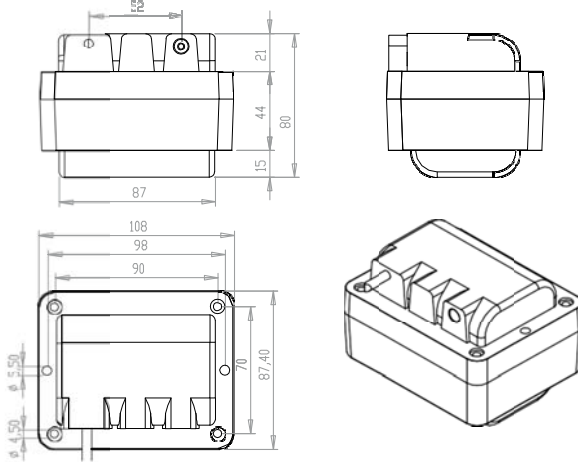

### Inlet | Ingressi

Standard buried cable  
Cavo annegato standard

COFI plug  
Presa perspina Cofi

Triangle plug  
Presa spina Triangolo

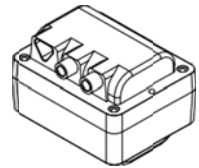
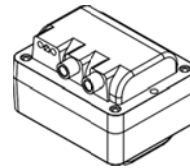
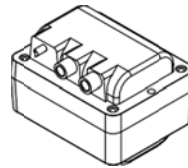

### Outlet | Uscite

Cod: SP

Cod: VIMAN

Cod: SPRAS

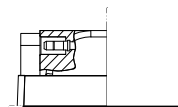
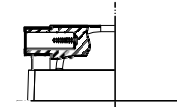
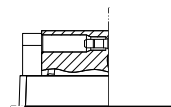

Cod: SPMAN

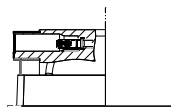

Type	Vin	Freq	Vout	Iout	ED	Output	Note
<b>CONTINUOUS 100%   CONTINUI 100%</b>							
TRG623PC US	120V	60Hz	1x6 kV	23 mA	100%	Grounded pole	
TRG820PC	230V	50Hz	1x8 kV	20 mA	100%	Grounded pole	
TRG1020PC	230V	50Hz	1x10 kV	20 mA	100%	Grounded pole	
<b>INTERMITTENT   INTERMITTENTI</b>							
TRG835P	230V	50Hz	1x8 kV	35 mA	25% on 4'	Grounded pole	
TRG1035P	230V	50Hz	1x10 kV	35 mA	25% on 4'	Grounded pole	

### Applications | Applicazioni



### Available certification | Certificazioni disponibili



# TRZ



The smallest conventional transformer of the range, especially developed for the anti-mosquito equipments.

Trasformatore economico di dimensioni estremamente ridotte per l'utilizzo in apparecchi stermi-natori di insetti.

## 2 POLES | 2 POLI

32



Technical drawing | Disegno tecnico [mm]

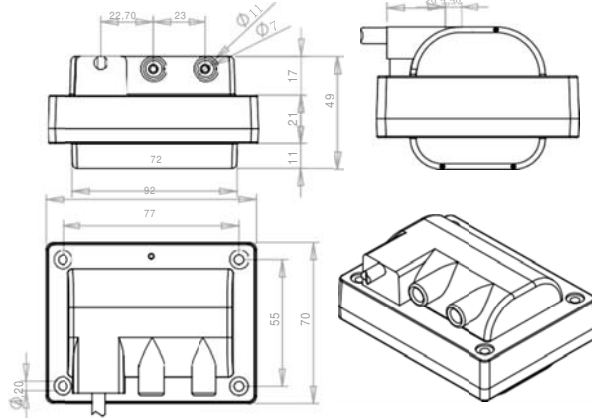

Inlet | Ingressi

Standard buried cable  
Cavo annegato standard

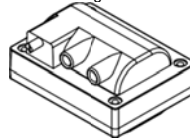

Outlet | Uscite

Cod: SP

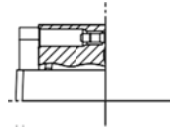

Type	Vin	Freq	Vout	I out	ED	Output	Note
TRZ410C	230V	50Hz	2x2 kV	10 mA	100%	Grounded center	CE
TRZ510C	230V	50Hz	2x2,5 kV	10 mA	100%	Grounded center	CE

## 1 POLE | 1 POLO



Technical drawing | Disegno tecnico [mm]

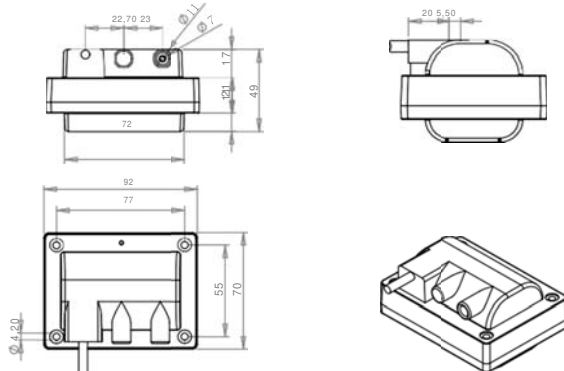

Inlet | Ingressi

Plug K | Presa per spina K

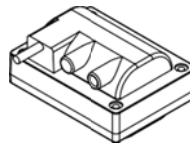

Outlet | Uscite

Cod: SP

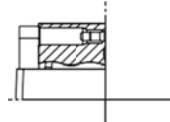

Type	Vin	Freq	Vout	I out	ED	Output	Note
TRZ4.509PC	230V	50Hz	1x4,5 kV	9 mA	100%	Grounded pole	CE

Applications | Applicazioni

Available certification | Certificazioni disponibili











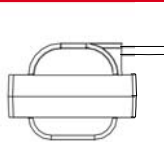



# ACCESSORI ES

ACCESSORI

## PRIMARY CONNECTIONS | CONNESSIONI PRIMARIE

33

 <p>Standard buried cable</p>	<p>Cavo annegato standard</p>	 <p>Plug A</p>	 <p>Spina A</p>	 <p>Plug B</p>	 <p>Spina B</p>	 <p>Plug C</p>	 <p>Spina C</p>
 <p>Plug D</p>	 <p>Spina D</p>	 <p>Plug T</p>	 <p>Spina T</p>	 <p>Plug K</p>	 <p>Spina K</p>		

## FILTERS | FILTRI



Inductive transformers  
EMI disturbance  
suppression filter

Code: **06CE061517**

Filtro soppressore  
disturbi EMI per trasformatori  
induttivi



# MOUNTING BRACKETS | STAFFE DI MONTAGGIO

---

40X40 mm galvanized bracket

Bracket for horizontal mounting of transformer on any surface.

Code: **15MI152457**

Kit with screws and nuts available

Code: **Staffa 1**

STAFFA 40X40 mm

Staffa per il montaggio in posizione orizzontale del trasformatore su una qualsiasi superficie

Kit con viti e bulloni disponibile



102X26 mm galvanized bracket

Bracket for vertical mounting of transformer on any surface.

Code: **15MI152452**

Kit with screws and nuts available

Code: **Staffa 2**

STAFFA 102X26 mm

Staffa per il montaggio in posizione verticale del trasformatore su una qualsiasi superficie

Kit con viti e bulloni disponibile



# ACCESSORI ES

## ACCESSORI

### 34 CONNECTI ONS AND PROTECTI ONS | CONNESSIONI E PROTEZIONI

 <p>Connector for faston 2,8x0,8mm for cable Ø5,2mm. per cavo Ø 5,2mm. Code: <b>11PC112031</b></p>	 <p>Bronze phosphor connector in Ø 4mm bronzo fosforoso for cable Ø 5,2mm 4 per cavi Ø 5,2mm Code: <b>11PC112004</b></p>	 <p>Bronze phosphor connector in Ø 4mm bronzo fosforoso for cable Ø 7mm 4 per cavi Ø 7mm Code: <b>11PC112010</b></p>	 <p>Bronze phosphor connector in Ø 6,3 mm for cable Ø 5,2 / 7mm straight without spring Bronze phosphor connector in Ø 6,3 mm for cable Ø 5,2 / 7mm dritto senza molla Code: <b>11PC112013</b></p>
 <p>Bronze phosphor connector in Ø 6,3 mm for cable Ø 5,2 / 7mm straight with spring Bronze phosphor connector in Ø 6,3 mm bronzo fosforoso 6,3 mm dritto con molla per cavi Ø 5,2 / 7mm Code: <b>11PC112011</b></p>	 <p>Bronze phosphor connector in Ø 6,3 mm for cable Ø 5,2 / 7mm 90° with spring Bronze phosphor connector in Ø 6,3 mm bronzo fosforoso a 90° con molla per cavi Ø 5,2 / 7mm Code: <b>11PC112018</b></p>	 <p>PVC overmolded protection for Ø 4mm plug for cable Ø 5,2 / 7mm per spine Ø 4mm per cavi Ø 5,2 / 7mm Protezione sovrastampata in PVC per spine Ø 4mm per cavi Ø 5,2 / 7mm Code: <b>17GO170000</b></p>	 <p>PVC overmolded protection for Ø 4mm 90° plug for cable Ø 5,2 / 7mm per spine Ø 4mm a 90° per cavi Ø 5,2 / 7mm Protezione sovrastampata in PVC per spine Ø 4mm a 90° per cavi Ø 5,2 / 7mm Code: <b>17GOST000K</b></p>
 <p>Silicone Cap L=35mm for cable Ø 5,2 / 7mm Used with inductive transformer VIMAN and SPMAN outlets. Cappuccio in gomma naturale o silicone per cavi Ø 5,2 / 7mm usati nei trasformatori induttivi con uscite VIMAN o SPMAN Code: <b>17GO172604</b></p>	 <p>Type A PBT straight terminal cap for cables Ø 5,2 / 7mm Copriterminale tipo A in PBT dritto per cavi Ø 5,2 / 7mm Code: <b>04PL041442</b></p>	 <p>Silicone cap for Ø 6,3mm 90° plug connector for cables Ø 5,2 / 7mm Copriterminale in gomma siliconica per connettore a 90° Ø 6,3mm per cavi Ø 5,2 / 7mm Code: <b>17GO172605</b></p>	 <p>Silicone cap for Ø 4mm 90° plug connector for cables Ø 5,2 / 7mm Copriterminale in gomma siliconica per connettore a 90° Ø 4mm per cavi Ø 5,2 / 7mm Code: <b>17GO172604</b></p>

### FINISHED CABLE LENGTHS | SPEZZONI DI CAVO CABLATI

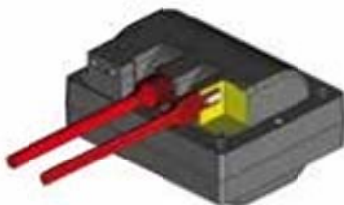

COFI realize primary and secondary silicone/copper or silicone/carbon fiber cables with custom-made lengths and finishing.

COFI realizza cavi primari e secondari in silicone/rame o silicone/fibra di carbonio con lunghezze e finiture su specifica.



#### PVC PROTECTI ON | PROTEZIONI IN PVC

Over molded on the cable ensures perfect sealing of the transformer outputs for protection against humidity in dirty and contaminated environments.

Sovrastampate sul cavo, garantiscono una perfetta tenuta delle uscite del trasformatore per una protezione dall'umidità in ambienti sporchi o contaminati.